



*Dependable Products From People You Trust*



## **Model 2040 Automated HTHP Consistometer**

**#120-40 - Consistometer  
#120-40-DAS - With Computer**

# **Instruction Manual**

**Updated 10/25/2023**

**Ver. 2**

**OFI Testing Equipment, Inc.**

*11302 Steeplecrest Dr. · Houston, Texas · 77065 · U.S.A.*

*Tele: 832.320.7300 · Fax: 713.880.9886 · [www.ofite.com](http://www.ofite.com)*

©Copyright OFITE 2022

# Table of Contents

<b>Requirements .....</b>	<b>3</b>
<b>Intro.....</b>	<b>3</b>
<b>Description.....</b>	<b>3</b>
<b>Features.....</b>	<b>3</b>
<b>Specifications .....</b>	<b>4</b>
<b>Components .....</b>	<b>4</b>
<b>Safety.....</b>	<b>7</b>
<b>Quick Start .....</b>	<b>9</b>
<i>Starting a Test.....</i>	<i>9</i>
<i>Completing a Test .....</i>	<i>10</i>
<b>Setup.....</b>	<b>11</b>
<b>Software .....</b>	<b>16</b>
<i>General Setup.....</i>	<i>16</i>
<i>Setup.....</i>	<i>17</i>
<i>Profile Builder.....</i>	<i>19</i>
<i>Main Screen .....</i>	<i>21</i>
<i>Events .....</i>	<i>24</i>
<i>Calculated Values .....</i>	<i>25</i>
<b>Onboard Display.....</b>	<b>26</b>
<i>Real-Time Data.....</i>	<i>27</i>
<i>Test Setup - Test Config.....</i>	<i>28</i>
<i>Test Setup - Profile.....</i>	<i>29</i>
<i>Calibrate.....</i>	<i>30</i>
<i>Utilities.....</i>	<i>31</i>
<i>Archive .....</i>	<i>32</i>
<i>Manual Control.....</i>	<i>33</i>
<i>Start Test.....</i>	<i>34</i>
<b>Operation .....</b>	<b>35</b>
<i>Filling the Slurry Cup.....</i>	<i>35</i>
<i>Starting a Test.....</i>	<i>37</i>
<i>Completing the Test .....</i>	<i>39</i>

<b>Maintenance .....</b>	<b>40</b>
<i>Cleaning.....</i>	40
<i>Potentiometer .....</i>	42
<i>Rupture Disk .....</i>	44
<i>Oil Filter.....</i>	45
<i>Pressure Relief Valve Regulator.....</i>	46
<i>Troubleshooting.....</i>	47
<b>Calibration.....</b>	<b>51</b>
<i>Potentiometer .....</i>	51
<i>Value Chart .....</i>	53
<i>Pressure.....</i>	54
<i>Temperature.....</i>	55
<b>Appendix .....</b>	<b>56</b>
<i>Metal Seal Ring Installation .....</i>	56
<i>Cell Diagram .....</i>	59
<i>Slurry Cup Diagram .....</i>	60
<i>Potentiometer Diagram .....</i>	62
<i>Potentiometer Adjustment.....</i>	63
<i>Fuses and Breakers.....</i>	64
<i>Multiple Instruments.....</i>	65
<b>Warranty and Return Policy .....</b>	<b>66</b>

## ***Intro***

During cementing operations, the time required for a cement slurry to set is of primary concern. Under an ideal situation, minimal time would be required to successfully pump the slurry, which immediately upon placement, begins to develop compressive strength. However, if insufficient time is allowed to fully pump the cement, it will be necessary to drill the cement remaining in the casing string. Remedial operations such as this are very costly. Conversely, cements that are successfully placed, but require considerable time to cure, consume valuable rig time, which is also quite costly. Laboratory tests should be conducted under simulated reservoir conditions to examine the actual thickening time of the slurry. The OFITE HTHP Consistometer was specifically engineered to determine the thickening time of well cements under simulated downhole pressures and temperatures.

## ***Description***

A cement is mixed and poured into the slurry cup assembly. The slurry cup is placed into the test vessel and pressure is increased via an air-driven hydraulic pump. A PID temperature controller governs an internal heater, which maintains the necessary temperature profile, while a magnetic drive mechanism rotates the slurry cup assembly. A potentiometer controls an output voltage, which is directly proportional to the amount of torque the cement exerts upon an API-approved paddle. The included software controls the instrument and records temperature, pressure, and cement consistency as a function of time.

## ***Features***

- Touch screen display for standalone operation
- Computerized Data Acquisition and Control system provides detailed test information in convenient formats and can control multiple units from one computer. RS-232, Ethernet, and USB connections available.
- Automatic temperature and pressure control
- External cooling jacket aids cooling of test cell
- Automatic, programmable speed motor (0–300 RPM) powered by a magnetic drive
- Easy-to-use two-piece lift-off cap for pressure cell
- Drip tray next to cap provides a place to set the cap between tests without dripping oil on the unit casing
- Convenient oil reservoir features a cap with built-in funnel to help prevent spills, a removable top and bottom that make cleaning easy, and a sloping bottom that collects sediment for easy removal
- Visual indicator provides an at-a-glance status update during testing
- Small footprint saves valuable lab space
- Temperature, pressure, and consistency alarms provide automatic shutdown for safety
- Conforms to API Specification 10 guidelines

## ***Requirements***

- Air/Nitrogen Supply (100–120 PSI/689.5–827.4 kPa)
- Water Supply for Cooling (40 PSI/276 kPa)
- Water Drain
- 220 Volt, 50/60 Hz, 25 Amp electrical power supply

# Specifications

<b>Size</b>	22.5" × 27.5" × 70"
<b>Weight</b>	Approximately 450 lb
<b>Crated Size</b>	26" × 34" × 76"
<b>Crated Weight</b>	Approximately 750 lb
<b>Temperature Controller</b>	Digital with 0.1° Resolution
<b>Pressure Indicator</b>	Digital transducer with 1 PSI (0.1 MPa) resolution. Analog gauge.
<b>Slurry Cup</b>	Variable Speed: 0–300 RPM
<b>Max Temperature</b>	600°F (315.5°C)
<b>(For tests above 400°F, refer to page 12)</b>	
<b>Max Pressure</b>	40,000 psi (276 MPa)

# Components

- #120-001 Mineral Oil, 1 Gallon (For tests at or below 400°F)
- #120-004 Phenylmethylsiloxane Silicone Fluid, PM-125, 1 gallon (For tests over 400°F)
- #120-10-1 Tool Kit (Includes slurry cup stand, slurry cup tool, lifting tongs for heater shield, and lifting tongs for potentiometer)
- #120-103 Rupture Disk, 45,000 PSI (310 MPa)
- #120-35-033 Air Filter
- #120-35-054 Drip Tray, Stainless Steel
- #120-35-132 Oil Filter
- #120-40-710 Thermocouple, Bath
- #120-40-711 Thermocouple, Slurry Cup
- #120-40-753 Backup Ring
- #120-40-755 Filter Element for High Pressure Filter
- #120-401 O-ring for Cell Cap, Metal
- #120-35-031 O-ring for Oil Reservoir, Viton
- #120-50-037 Air Regular
- #120-521 Slurry Cup with Expansion Chamber
- #120-628 Potentiometer Assembly
- #120-75-10 Slotted Weight Set
- #120-75-9 Weight Hanger
- #130-75-28 Allen Key, 1/16", 1 1/4" Long
- #130-77-027-1 Pump
- #141-28 Hose Kit
  - #141-15 Air Hose, 6', Qty: 2
  - #141-19 Air Hose Adapter, Qty: 6
  - #141-27 Drain Hose, Stainless Steel
- #113-00-022 Gauge, 0 - 100 PSI

**Potentiometer Components:**

#120-602	Calibration Spring
#120-603	Potentiometer Body
#120-604	Potentiometer Resistor
#120-605	Contact Spring
#120-606	Potentiometer Contact Arm
#120-607	Contact Strip
#120-608	Grounding Cable Retaining Screw
#120-609	Grounding Contact Spring

**Slurry Cup Components:**

#120-501	Slurry Cup Sleeve
#120-502	Molded Diaphragm (For tests at or below 400°F)
#120-40-502	Diaphragm (For tests above 400°F)
#120-503	Paddle Pin
#120-504	Pivot Bearing
#120-505	Pivot Bearing Gasket
#120-506	Paddle
#120-508	Diaphragm Retaining Ring
#120-509	Drive Disk
#120-510	Drive Bar
#120-512	Drive Pin
#120-513	Gasket for Bottom Cap
#120-514	Drive Disk Set Screw, 6-32 × 3, Stainless Steel







**Optional:****#120-40-SP**

#120-001	Mineral Oil, 1 Gallon, Qty: 2
#120-103	Rupture Disk, 45-50 KSI, Qty: 2
#120-212	Heater Assembly, 5000 Watt
#120-401	O-ring for Cell Cap, Metal, Qty: 10
#120-40-502	Diaphragm (For tests above 400°F), Qty: 25
#120-40-711	Thermocouple, Slurry Cup, Qty: 2
#120-501	Slurry Cup Sleeve
#120-502	Molded Diaphragm, Qty: 25
#120-503	Paddle Pin, Qty: 12
#120-504	Pivot Bearing, Qty: 6
#120-505	Pivot Bearing Gasket, Qty: 5
#120-506	Paddle for Slurry Cup, Qty: 4
#120-508	Diaphragm Retaining Ring, Qty: 2
#120-509	Drive Disk for Slurry Cup
#120-510	Drive Bar for Slurry Cup
#120-511	Shear Pin for Slurry Cup, Qty: 24
#120-512	Drive Pin for Slurry Cup, Qty: 12
#120-513	Gasket for Slurry Cup, Qty: 6
#120-514	Drive Disk Set Screw, Qty: 10
#120-520	Paddle Shaft, 9 1/8", Qty: 10
#120-521	Slurry Cup with Extension
#120-602	Calibration Spring, Qty: 3
#120-604	Potentiometer Resistor, Qty: 4

**Spare Parts Kit**

#120-606 Potentiometer Contact Arm, Qty: 6  
#120-607 Contact Strip, Qty: 6  
#120-608 Grounding Cable Retaining Screw  
#120-619 Pan Head Screw, Phillips, 2-56 × .125 Length, Qty: 5  
#120-620 Potentiometer Main Bearing, Qty: 4  
#120-626 Shaft Alignment Bearing, Qty: 4  
#120-684 Bearing, Bronze, Large, Qty: 2  
#120-074-1 Fuse, 5 Amp, 5 mm × 20 mm, Qty: 6  
#130-75-28 Allen Key, 1/16", Qty: 2

# Safety

Explanation of Symbols	
	<b>Caution: Risk of Danger</b> - This symbol directs the operator to consult the instruction manual for safety related warnings. (ISO-7000-0434) <b>Whenever this symbol is used on the equipment, the user must consult the manual to determine the nature of the hazard and any actions which have to be taken.</b>
	<b>Hot:</b> This symbol indicates that a surface may be hot to the touch.
	<b>Shock Hazard:</b> This symbol indicates a risk of electrical shock.
 Note	<b>Note:</b> This symbol will indicate important notes and helpful hints for the operation of the equipment.
 Tip	<b>Tip:</b> This symbol is used to identify operational information and best practices to obtain the most reliable data.
	<b>Caution: Note</b> - This symbol is used to indicate statements in the manual which warn against actions which may cause damage to the equipment during routine service or maintenance.



- The Consistometer conforms to the relevant safety regulations; however the user is solely responsible for the correct handling and proper usage of the instrument.
- The equipment should be operated in such a way that will not endanger people.
- The equipment must not be operated if there is any evidence of external damage, leading to any doubt regarding safe operation.
- The user must comply with the instructions in this instruction manual, otherwise safe operation cannot be guaranteed.
- This instruction manual must be readily available for all operators.
- Do not bend or stress connection cables and mains cable.
- Do not subject connection or mains cables to high temperatures (higher than 70°C).
- Check integrity of cables at regular intervals.
- The unit must be powered down before any cables are connected or disconnected. This reduces the risk of electrostatic charging and resultant damage to electronic circuit boards.
- The operator must have a good familiarity with the installation of the unit and its surroundings.
- Suitable protective gear should be worn in the factory environment in which the unit has been installed.
- The unit should be serviced at regular intervals as detailed on page 40.
- The user is responsible for the safe handling of any materials tested. If in doubt the material safety data sheet should be read, relevant safe handling regulations should be read and observed and good operating and manufacturing practices should be followed.

# Quick Start

## Starting a Test



1. Before turning on the Consistometer, make sure the MOTOR, HEAT, COOLING, PUMP, and FILL/DRAIN CELL switches are all off.
2. Turn the MAIN POWER switch on.
3. Turn the MOTOR switch to ON.
4. Slowly lower the slurry cup into the test cell until the drive table engages with the drive pins on the bottom.
5. Lower the potentiometer into the test cell so that it sits on top of the slurry cup.
6. Turn the MOTOR switch to AUTO.
7. Carefully lower the cell cap into the test cell and tighten it.

**If you are using a metal o-ring and you tighten the cell cap past the marked position, you must use a new o-ring for the next test.**

8. Plug the thermocouple into the port near the test cell. Insert the thermocouple into the hole in the top of the cell cap and tighten the thread gland finger tight and loosen it  $\frac{1}{4}$  of a turn.
9. Close the pressure release valve by turning it clockwise.
10. Turn the FILL/DRAIN CELL switch to FILL. When the cell is full, oil will leak out of the thermocouple fitting on the cell cap. Tighten the fitting to seal the cell.



**Leave the FILL/DRAIN CELL switch in the FILL position during testing.**

11. Turn the HEAT, COOLING, PUMP, and POT VOLTS switches to AUTO.
12. Turn the DAQ PAUSE switch to OPERATE and the ALARM switch to ON.
13. Load the test:
  - a. If you will be using the software to run the test, select a Test Profile and click the Start Test button on the Main Screen (see page 21).
  - b. If you will be using the onboard controls to run the test, first select a test to run (see page 29), then touch the Start Test button.

# Quick Start

## Completing a Test



When the test is complete, the red light on the Status Indicator will turn on and an alarm will sound. To acknowledge the alarm, touch the alarm icon.

1. Stop the test:
  - a. If you are using the software to run the test, click the Stop Test button.
  - b. If you are using the onboard controls to run the test, touch the Stop Test button.
3. Turn the HEAT and MOTOR switches off.
4. When the cell temperature has reached 150°F, turn the PUMP switch off and slowly open the Pressure Release valve.

**Never release pressure while the temperature is above 200°F (93.3°C).**

5. Turn the FILL/DRAIN CELL switch OFF for 5 seconds. Then set it to DRAIN. This will allow air into the test cell and force the oil back into the reservoir.
6. When you hear air venting from the Consistometer, turn the FILL/DRAIN CELL switch off.
7. Remove the thermocouple from the cell cap.
8. Unscrew the cell cap and remove it from the test cell.
9. Remove the potentiometer and the slurry cup from the test cell.
10. Turn the COOLING switch off.
11. Return the cell cap to the test cell to prevent dust and other material from entering the cell.
12. Turn the MAIN POWER switch off.

# Setup



1. Carefully remove the instrument from the wooden crate.
2. Once the unit is in place, lock the casters by depressing the lever on the side. This will prevent the unit from moving.
3. Make sure all valves are closed and all switches are off. Connect an air or nitrogen (100–120 PSI/690–827 kPa) supply to the air supply on the back of the instrument.

This unit uses ¼" NPT female connectors for all supply lines.

4. Connect the drain and coolant supply lines, also on the back of the unit.
5. The consistometer has two power inlets on the back of the cabinet. The MAIN POWER inlet provides power to the entire unit. The BACK-UP POWER inlet is optional. It powers the electronics only.

To protect the electronics from a power outage, plug the BACK-UP POWER into an uninterruptible power supply (UPS). In the event of a power outage, the heaters will shut off, but the rest of the electronics will continue to work and the test will keep running.





- To fill the oil reservoir, remove the right-hand side panel and remove the oil reservoir cap. Pour approximately four liters (or until full) of oil into the reservoir. Replace the cap. Make sure the seal is air tight. Use the sight glass on the front to check the oil level.

**Mineral Oil (#120-001) is recommended for tests up to 400°F. For tests above 400°F, use only Phenylmethsiloxane Silicone Fluid (#120-004).**

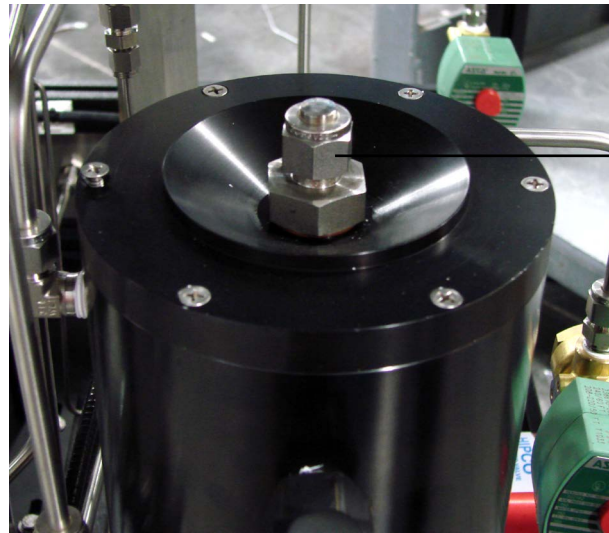

Reservoir  
Cap

- Turn the “Main Power” switch On.
- Calibrate the potentiometer before connecting the Consistometer to a computer. See page 51.

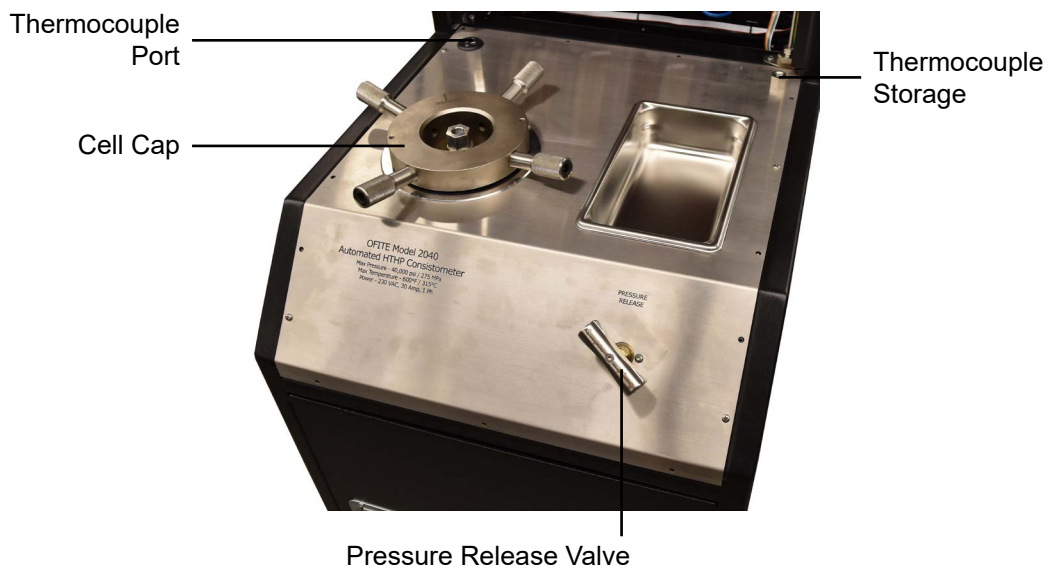

**Status Indicator:**

The lights on the Status Indicator correspond to the consistency of the sample. The threshold values can be set in either the onboard controls or in the software. There are three setpoints, specified in Bearden units of consistency (Bc).

- Max Bc for Green Light: When the consistency is below this value, the green light will be on.
- Max Bc for Green and Yellow: When the consistency is below this value, the green and yellow lights will both be on.
- Max Bc for Red Light: When the consistency is below this value, the yellow light only will be on. When the consistency is above this value, the red light will be on and the test will stop.

Refer to page 18 for instructions on setting these values.

The Status Indicator also indicates an alarm condition. If an alarm is triggered, all three lights on the status indicator will blink until the alarm is acknowledged.

**Switches:**

- FILL/DRAIN CELL: Controls the flow of oil into the cell.
  - DRAIN: Oil flows out of the cell and into the reservoir.
  - OFF: The oil is not moved in either direction.
  - FILL: Oil flows out of the reservoir and into the cell for testing.
- POT VOLTS: Controls power to the potentiometer
  - ON: Power is supplied to the potentiometer.
  - AUTO: Power is only supplied to the potentiometer only during a test or calibration.
- DAQ PAUSE:
  - PAUSE: No test data is collected
  - OPERATE: Test data is collected
- MOTOR: Sets control of the motor
  - AUTO: The motor will turn according to the parameters of the test that is currently running. If no test is running, the motor will be stopped.
  - OFF: The motor will not turn at all.
  - ON: The motor will turn at 150 RPM until stopped.
- ALARM: Turns the audible alarm on or off.

- HEAT: Controls power to the heating system.
  - AUTO: The heater is controlled by the parameters of the test that is currently running. If no test is running, the heater will be off.
  - OFF: The heater is off.
  - ON: The heater can be controlled by the software or onboard displayed in Manual mode (see 33).
- COOLING: Controls the cooling system
  - AUTO: The cooling system is controlled by the parameters of the test that is currently running. If no test is running, the cooling system will be off.
  - OFF: The cooling system is off.
  - ON: The cooling system is on.
- PUMP: Controls power to the pump
  - AUTO: The pump is controlled by the parameters of the test that is currently running. If no test is running, no pressure will be applied.
  - OFF: No pressure will be applied.
  - ON: The pump can be controlled by the software or onboard display in Manual mode (see 33).

### **Thermocouple**

The Consistometer uses two thermocouples for reading temperature. One is inside the unit cabinet and measures the temperature of the oil bath around the slurry cup.

The other is outside the unit cabinet. This one must be inserted into the top of the cell cap so that it reaches down into the slurry cup and measures the temperature of the slurry.

When the thermocouple is not in use, store it in the port on the right-hand side of the cabinet to protect it from damage.

### **Pressure Release Valve**

This valve releases the pressure in the test cell. To release the pressure, slowly turn the valve counterclockwise. Always make sure the pump is turned off and the cell temperature is below 200°F before releasing the pressure.

**Always release the pressure very slowly to avoid pulling cement into the plumbing.**





# Software

## General Setup



1. Open the software.

The software must be run with Administrator privileges. There are two ways to do this:

- a. Right-click the icon and select “Run as Administrator”.
  - b. Right-click the icon and select “Properties”. On the Compatibility tab, check the box next to “Run this program as an administrator” and click OK.
2. When the Manage Devices screen appears, right-click the device from the list and select “Set as Default”. Then click “Done”.

Make sure to enable the appropriate communication method for your device. If you have connected the Consistometer to the PC via USB, select “Enable USB Comms”, etc.

Depending on the connection types you enable, your device might show up multiple times or other OFITE equipment might appear on the list. Make sure you select the correct device and connection type you wish to use.

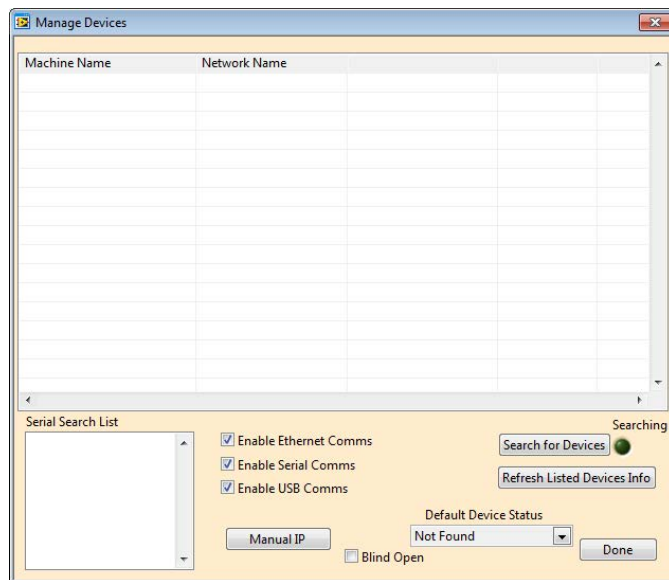

3. Choose “Options” from the “Edit” menu on the main software screen.
4. Select a folder to save all test data and click “OK”.

# Software Setup

1. Select Edit → Test
2. On the Information tab, enter the necessary information.

All fields on this tab are optional.

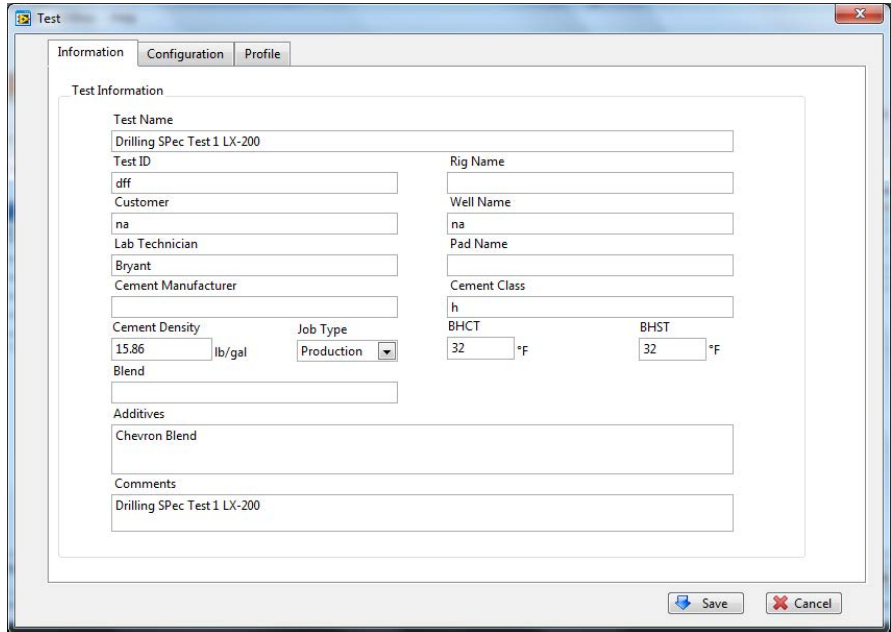

3. On the Configuration tab, set the following parameters:

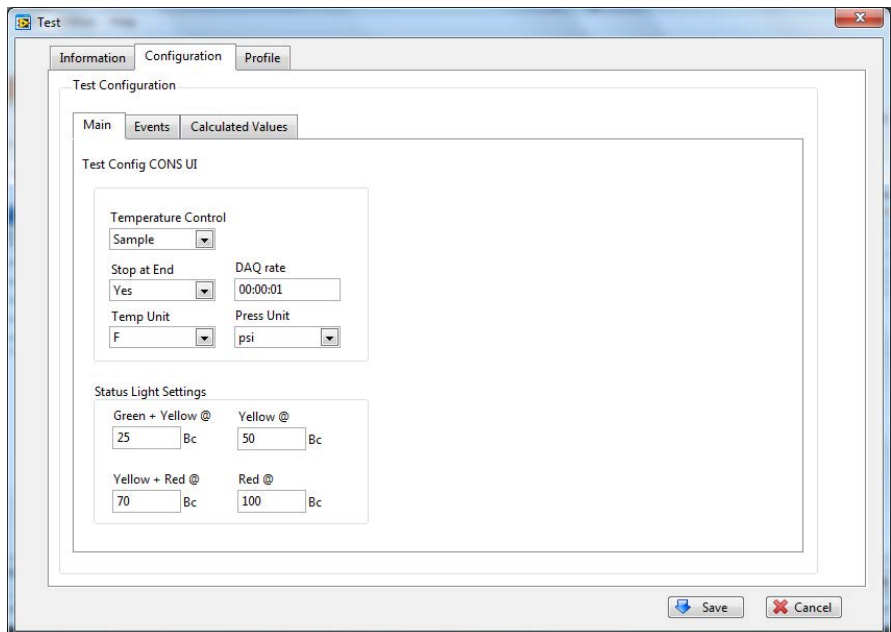

**Temperature Control:** The instrument has two thermocouples. One is in the cement sample in the cell. The other is in the heating jacket (Bath). Use this option to determine which thermocouple will be used to control the temperature. The “Sample” setting is recommended during testing. The “Bath” setting is recommended during pre-heat.

**Stop at End:** When this option is “No”, the test will run until you click the “Stop Test” button. The final temperature and pressure setpoints will be maintained indefinitely. If this option is “Yes”, the test will end when all steps in the Test Profile are complete.

**DAQ Rate:** Set the interval for data points to be recorded (hh:mm:ss).

**Temp Unit:** Choose either F (Fahrenheit) or C (Celsius)

**Press Unit:** Choose units for cell pressure (psi or MPa)

**Status Light Settings:** Enter the threshold (in Bc) for each level on the status indicator. When the consistency of the cement reaches one of these thresholds, the corresponding light(s) on the indicator will turn on.

4. On the Profile tab, select a Test Profile from the list. To create a new Test Profile, click the “Open Builder” button (page 19).

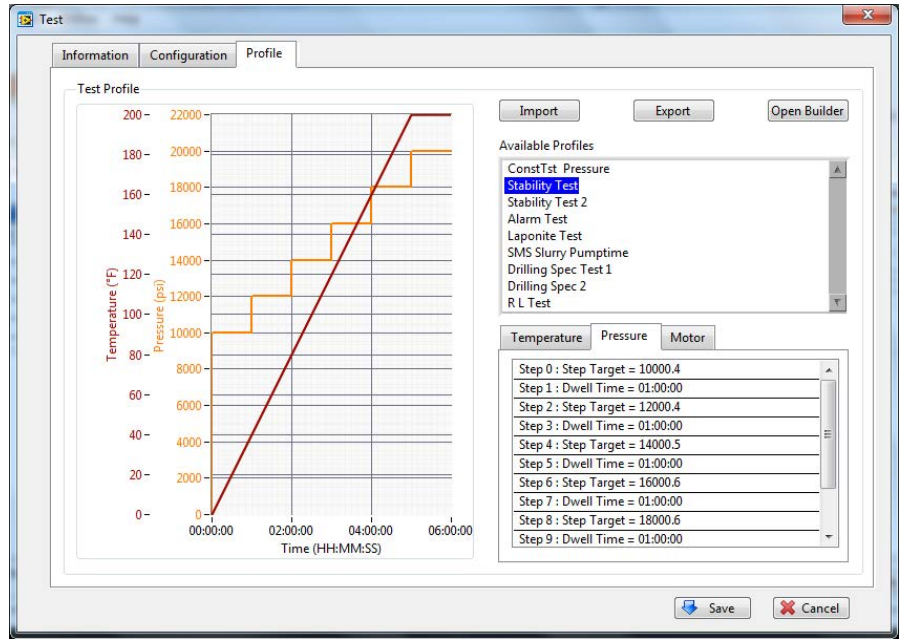

5. Click “Save”

# Software

## Profile Builder

The Test Profile Builder creates temperature, pressure, and motor profiles for Consistometer tests.

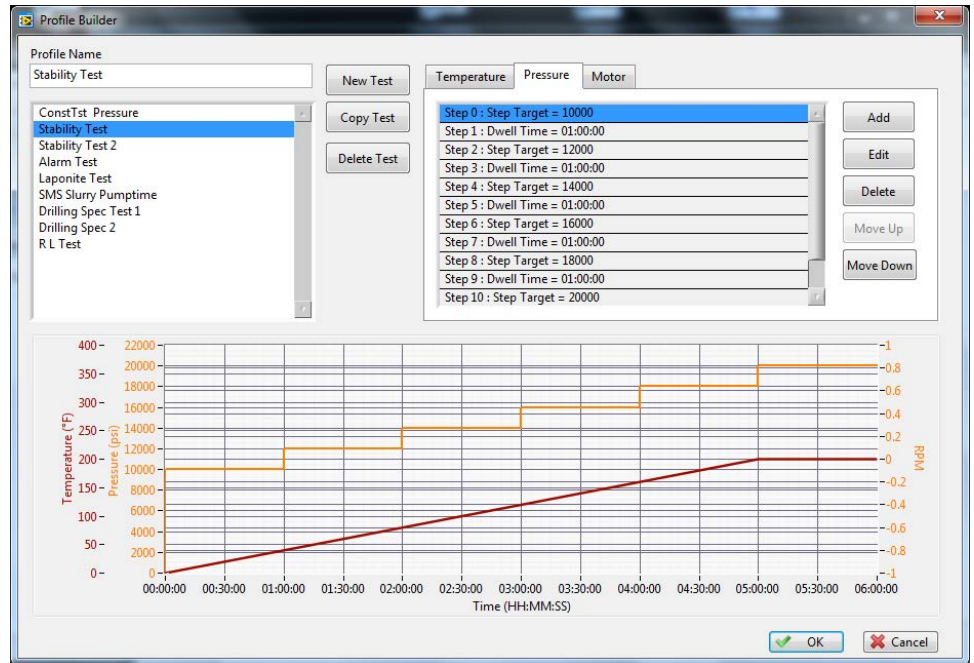

1. Select Edit → Test. On the Profile tab, click the “Open Builder” button.
2. Click "New Test" to build a new test profile. To edit a current test profile, select a test from the list on the left-hand side by double clicking on the appropriate test
3. In the "Profile Name" box, enter a test name.
4. Each test profile has three parameters: temperature, pressure, and motor speed. For each parameter, there is a series of steps. Each step specifies the setpoint and other options for that parameter.

To add a step, click the Temperature, Pressure, or Motor tab and then click the “Add” button. As you add steps to the test profile, the graph below will change to reflect the new data.



Note

**When building a test at temperatures above 190°F (87.8°C), the unit will calculate and apply a minimum pressure to prevent the sample from boiling.**

There are three types of steps:

- Ramp – This will increase the temperature or pressure up to the target in a set number of minutes. You will be prompted for the ramp time (hh:mm:ss) and target.



- Step – This will increase the temperature or pressure up to the target as fast as possible. Enter the target in the "Target" box.
- Dwell – This will hold the current temperature or pressure for a set number of minutes. Enter the time (hh:mm:ss) into the "Time" Box.

The maximum temperature setpoint allowed is 600°F (315.6°C). The unit allows pressure setpoints up to 40,000 psi (275.8 MPa). The units of measure will be the same as entered in the Setup menu (see page 17).

5. To edit an existing step, double click the step in the step list or highlight the existing step and select the "Edit" button. Click OK when done.
6. Click the "OK" button to exit the "Setup" screen. The new Temperature Profile will now appear in the "Available Profiles" list on the "Profile" tab.

The screenshot shows a window titled "Setup" with a close button in the top right corner. Inside the window, there are three input fields on the left and two buttons on the right. The first field is "Step Type" with a dropdown arrow, currently showing "Ramp". The second field is "Time (min)" with a text box containing "00:00:00". The third field is "Target" with a text box containing "0". The "OK" and "Cancel" buttons are positioned to the right of the input fields.

# Software

Main Screen

The software has a set of five tabs. Each tab shows different information.

The **Info** tab shows the test information.

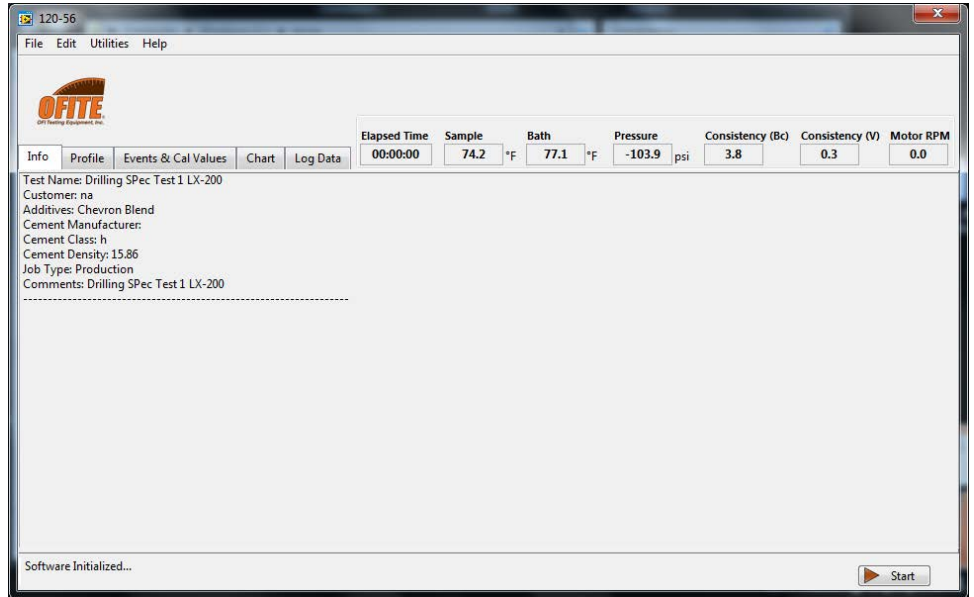

The **Profile** tab shows a graph of the Test Profile and details about each step.

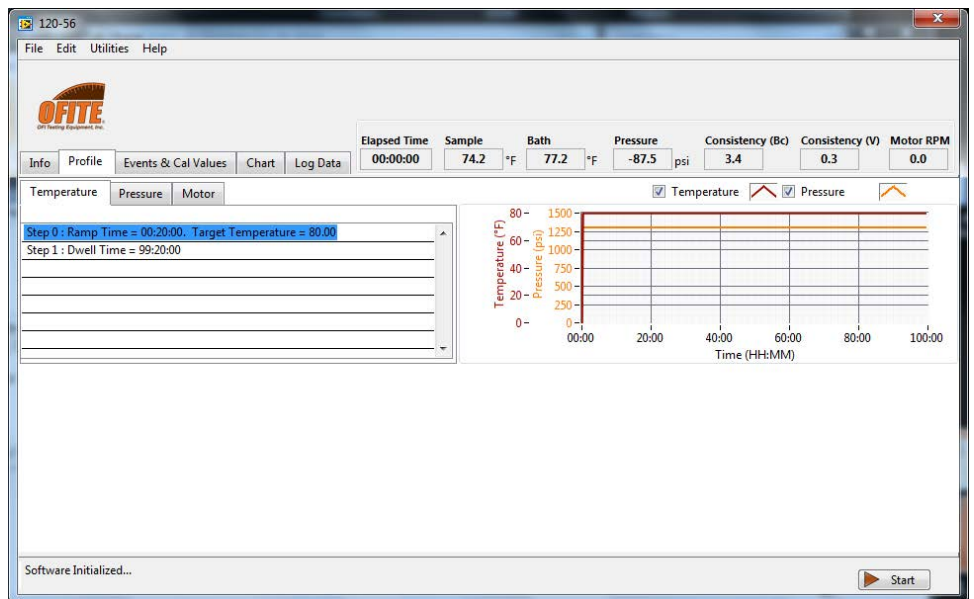

The **Chart** tab shows a graph of the current test conditions.

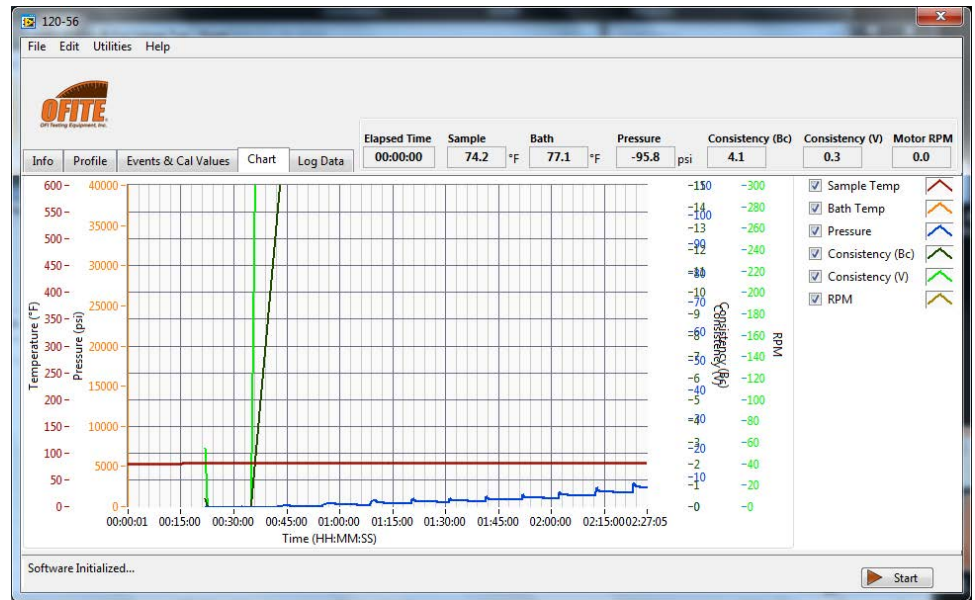

The **Log Data** tab shows the data for the current test.

The **Events & Cal Values** tab shows any calculated values or events that have been triggered.

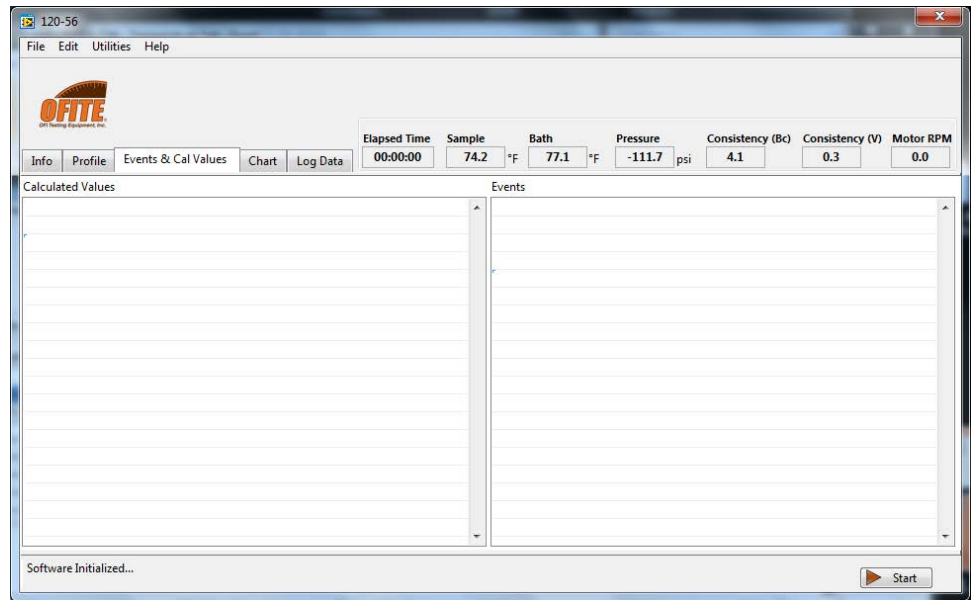



# Software

## Events

Events are triggered based on conditions in the test. When an Event is triggered, it can send an alert, end the test, or both.

To manage Events, choose Test from the Edit menu. Then go to the Configuration tab and then the Events tab.

1. Choose a Signal: Time, Temperature, Pressure, BC, Compressive Strength, Gel Strength, Transition Time, Expansion.
2. Enter the Value you want to test for. For example, if your Signal is Temperature, then a Value of 100 represents 100°.
3. Enter the time (in seconds) you want the Signal to be at the specified Value before triggering the event.
4. Choose a Condition.
5. If you want to be alerted when the conditions are met, select Enable under Alert.
6. If you want the test to end when the conditions are met, select Enable under End Test.
7. Click the Add button to add the Event.
8. To modify an Alert, select it in the list, make your changes, and then click the Update button.
9. Click Save.

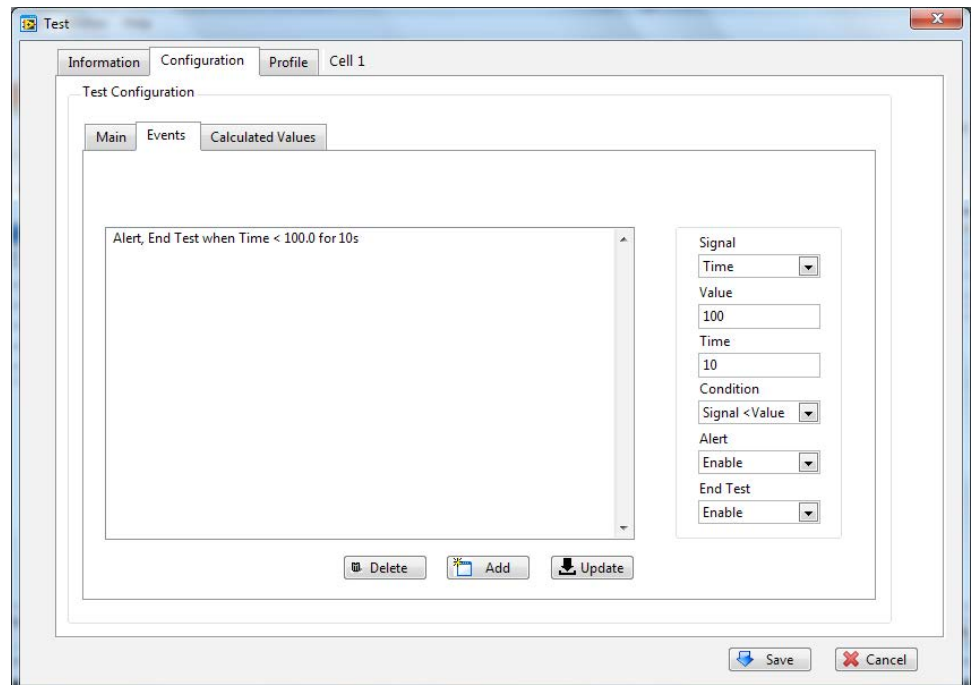

# Software

## Calculated Values

Calculated Values are triggered by conditions in the test. They are printed on the chart at the end of the test.

To manage Calculated Values, choose Test from the Edit menu. Then go to the Configuration tab and then the Calculated Values tab.

1. Choose a Signal: Time, Temperature, Pressure, BC, Compressive Strength, Gel Strength, Transition Time, Expansion.
2. Choose a Calculation:
  - **At Time:** Calculate the value of the Signal at a specific test time
  - **Time When:** Calculate the time when the Signal reaches a specified value
  - **Signal Min:** Calculate the minimum Signal value for the test
  - **Signal Max:** Calculate the maximum Signal value for the test
  - **Transition Time:** Calculate the time it takes the Signal to change from one value to another
3. Fill in the remaining fields. These fields will change depending on which Calculation you choose.
4. Click the Add button to add the Calculated Value.
5. To modify a Calculated Value, select it in the list, make your changes, and then click the Update button.
6. Click Save.

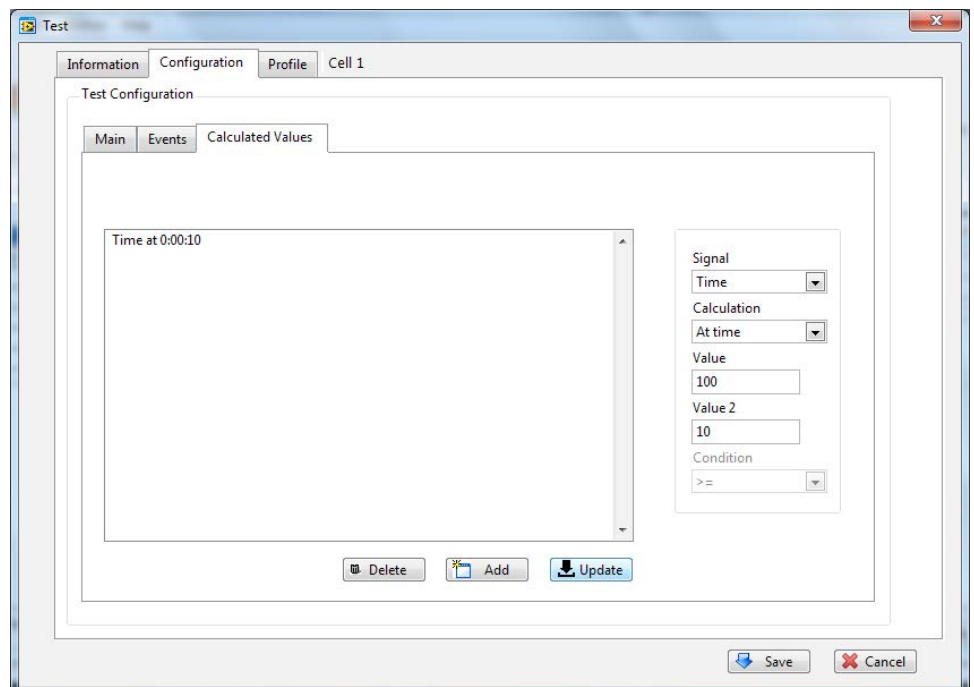

## ***Onboard Display***

The Consistometer features an onboard display. It provides access to basic test configuration and control and makes it possible to run the instrument without an external computer. The display can be operated either as a touch-screen or with the control wheel.

To operate the display with the Control Wheel:

1. Turn the Control Wheel to scroll through the available parameters.
2. Press the Control Wheel to select a parameter.
3. Turn the Control Wheel to scroll through available values for the parameter.
4. Press the Control Wheel to select a value.

# Onboard Display

## Real-Time Data

The Real-Time Data screen is the default screen. When the display has been idle for more than 2 minutes, it will automatically revert to this screen. Here you can see the current test parameters. This screen does not accept any inputs.

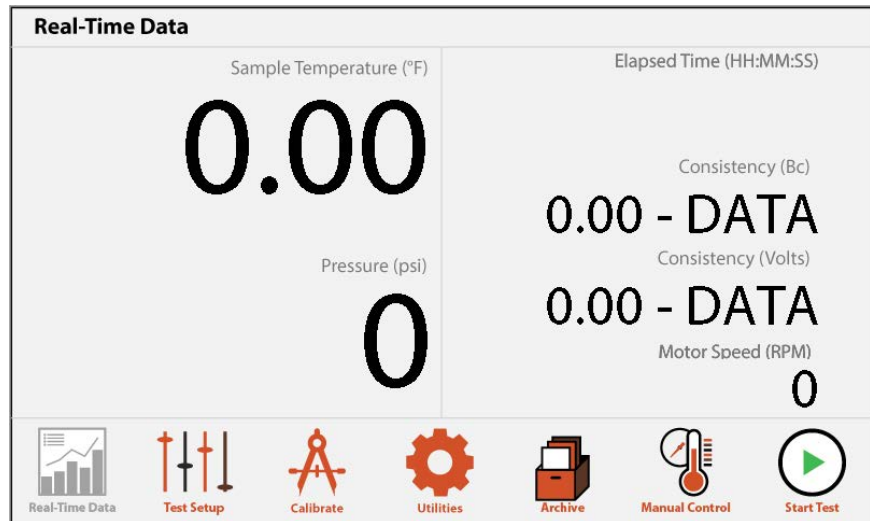

Real-Time Data

# Onboard Display

## Test Setup - Test Config

On the Test Config tab of the Test Setup screen, you can set thresholds for the indicator lights on the top of the unit.

1. Go to the Test Setup screen and select “Test Config”.
2. Enter a consistency value (in Bc) for each threshold:

**Signal LED G/Y:** When the consistency reaches this level, the green and yellow lights will come on.

**Signal LED Y:** When the consistency reaches this level, the yellow light will come on.

**Signal LED Y/R:** When the consistency reaches this level, the yellow and red lights will come on.

**Signal LED R:** When the consistency reaches this level, the red light will come on.

3. Select “Save” when done.

The screenshot shows the 'Test Configuration' screen. On the left, there is a sidebar with 'Test Config' and 'Profile' options, and a 'SAVE' button. The main area contains four input fields for setting consistency values (Bc) for different LED signals: 'Signal LED - G/Y (Bc)', 'Signal LED - Y (Bc)', 'Signal LED - Y/R (Bc)', and 'Signal LED - R (Bc)'. At the bottom, there is a navigation bar with icons for 'Real-Time Data', 'Test Setup', 'Calibrate', 'Utilities', 'Archive', 'Manual Control', and 'Start Test'.

# Onboard Display

## Test Setup - Profile

On the Profile tab of the Test Setup screen, you can create a Test Profile for your test.

1. Choose a Parameter (Temperature, Pressure, or Motor).
2. Choose a Step Type:

### Temperature and Pressure

**Ramp:** This will increase the temperature or pressure up to the target in a set number of minutes. Enter the ramp time and target.

**Step:** This will increase the temperature or pressure up to the target as fast as possible. Enter the target temperature or pressure.

**Dwell:** This will hold the current temperature or pressure for a set number of minutes. Enter the time.

**Motor:** On or Off

3. Enter the parameters for the step (ramp time, target temperature, motor speed, etc).
4. Select the “ADD STEP” button.
5. To remove a step, select it in the list and select the “REMOVE STEP” button.
6. When you are finished adding steps, select the “SAVE” button.

The screenshot shows the 'Test Setup Profile Builder' interface. On the left, there are two menu items: 'Test Config' and 'Profile', both with right-pointing chevrons. Below these is a large 'SAVE' button. The main area is titled 'Add Step' and contains a large empty box for a list of steps. To the right of this box are two columns of controls. The first column is labeled 'Parameter' and has a dropdown menu currently set to 'Temperature'. Below it is a 'Type' dropdown menu set to 'Ramp'. Under 'Type', there are two input fields: 'Time (min)' with the value '0' and 'Temperature (°F)' with the value '0'. Below these input fields are two buttons: 'ADD STEP' and 'REMOVE STEP'. At the bottom of the screen is a navigation bar with seven icons: 'Real-Time Data' (bar chart), 'Test Setup' (sliders), 'Calibrate' (compass), 'Utilities' (gear), 'Archive' (box), 'Manual Control' (thermometer), and 'Start Test' (play button).

# Onboard Display

## Calibrate

On the Calibrate screen, the onboard display can calibrate the pressure transducer, thermocouple, and potentiometer. It can also perform a Drag Check.

1. Select the system (Pressure, Temperature, Consistency) to calibrate.
2. Follow the onscreen instructions.

**Pressure:** See page 54.

**Temperature:** See page 55.

**Consistency:** See page 51.

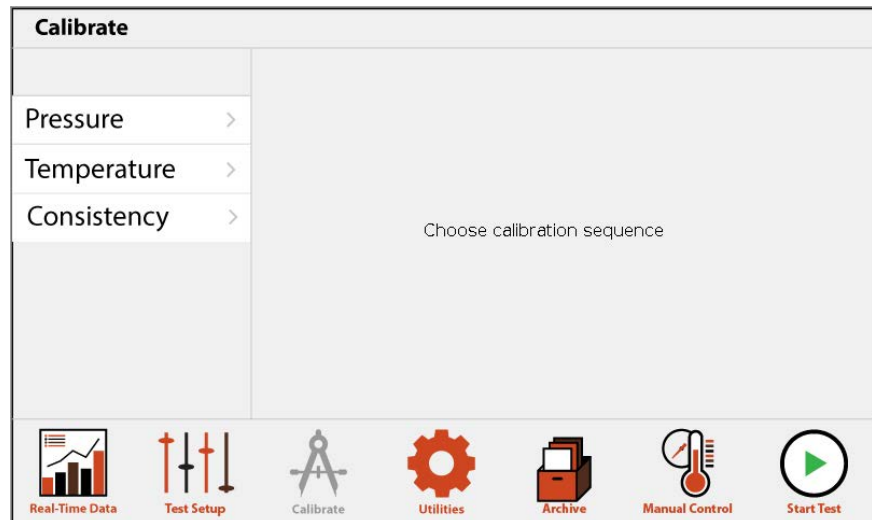

# Onboard Display

## Utilities

The Utilities screen sets general parameters.

1. Enter the values for each parameter:

**Display Temperature:** The instrument has two thermocouples. One is in the cement sample in the cell. The other is in the heating jacket (Bath). Use this option to determine which thermocouple will be used to control the temperature. Sample is recommended during testing. But Bath is recommended during pre-heat.

**Temperature:** Choose either °F (Fahrenheit) or °C (Celsius)

**Pressure:** Choose units for cell pressure (psi or MPa).

2. Select “Apply” when done.

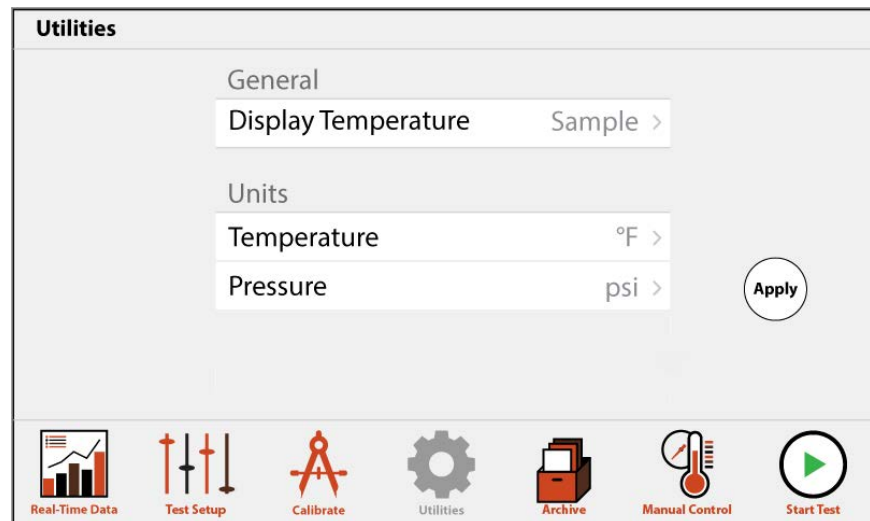



# Onboard Display

## Archive

On the Archive screen, saved calibrations and tests can be exported to a USB drive.

1. Place a USB drive in the port on the left-hand side of the instrument.

The port has an indicator light to show the status of the inserted drive:

- a. Green: The drive is inserted and supported.
  - b. Amber: The drive is inserted and supported, but low on free space.
  - c. Red: The drive is inserted but not supported. Make sure the drive is formatted in the FAT32 file system.
2. On the left-hand side of the screen, choose either Tests or Calibrations. The list of available tests or calibrations will populate on the right.
  3. Choose the item to export.
  4. Select "Export". The file will be saved to the USB drive.

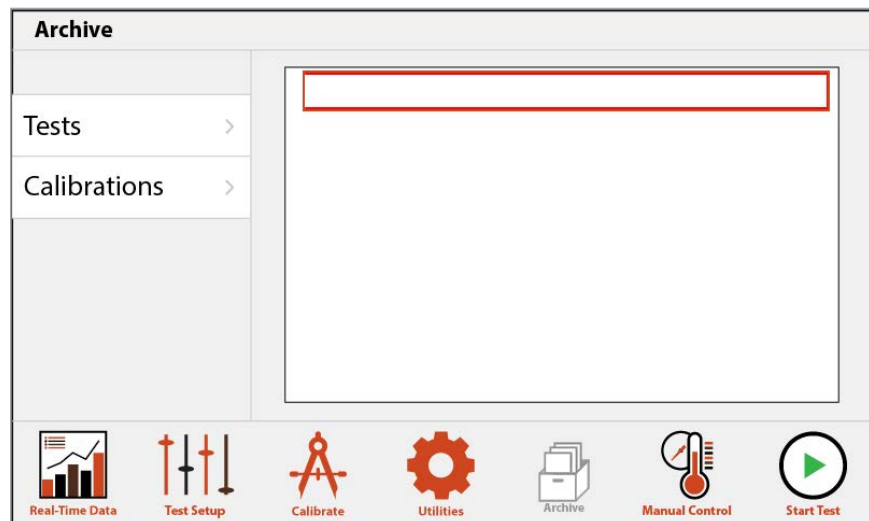

# Onboard Display

## Manual Control



Note

The Manual Control screen can be used to set the temperature, pressure, and/or motor when a test is not running. The relevant switch (HEAT, PUMP, or MOTOR) must be set to MANUAL.

1. On the left-hand side of the screen, choose Temperature, Pressure, or Motor.
2. Enter the setpoint in the box.
3. Select "SET" when done.

When setting the temperature with Manual Control, the controller will use the thermocouple specified in the Utilities screen (Bath or Cell). If the Cell thermocouple is selected, a thermocouple must be connected to the port on the bulkhead to prevent alarms.

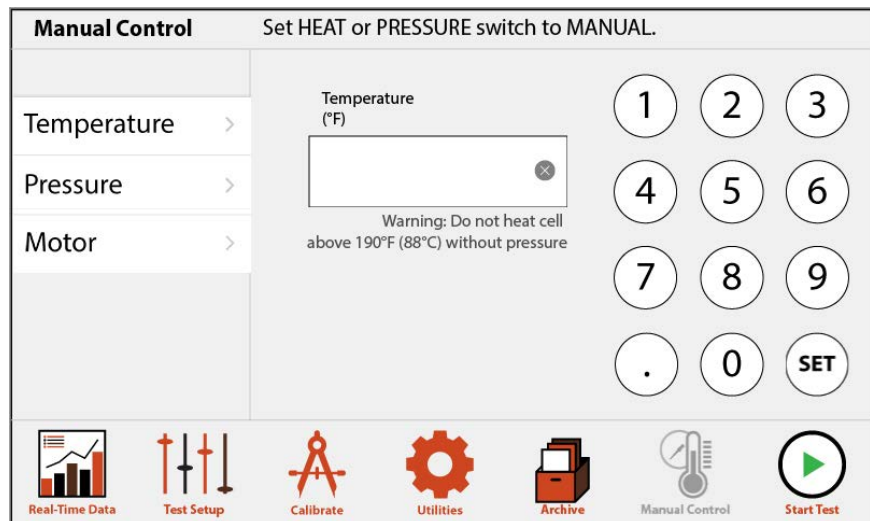

# ***Onboard Display***

## *Start Test*

The Start Test button starts a test using the parameters that are currently saved to the internal board. Before pressing the Start Test button, be sure to configure your test parameters on the Test Setup screen (see page 29) or in the PC software (see page 19).



Also note, when saving settings in the onboard display, the settings displayed on the screen will be saved to the board, but other settings that were previously set in the software will be replaced by defaults.



# Operation

## Filling the Slurry Cup

Three diaphragms are available for the slurry cup. For tests below 400°F, use OFITE part number 120-502. For tests above 400°F, use OFITE part number 120-40-502. For tests below 200°F, use OFITE part number 120-502-1.

1. With the slurry cup disassembled, examine the threads on the inside of the sleeve. The end with the larger set of threads is the top.
2. Coat the top and bottom threads of the slurry cup with a high-temperature grease to facilitate disassembly.
3. Insert the paddle assembly all the way into the top of the sleeve.



Sleeve



Paddle

4. Slide the slurry cup lock ring on top of the paddle assembly with the two notches facing upward. Tighten the locking ring completely using the provided slurry cup tool.



Base

Gasket



Locking Ring

5. Prepare the cement slurry as stated in API Specification 10.
6. Pour the cement into the slurry cup through the open bottom of the sleeve.
7. Place the metal o-ring around the threads of the base. Apply high-temperature grease to the o-ring and base surface. Screw the base onto the cup and tighten with the slurry cup tool.



The slurry cup should contain enough cement slurry that it leaks out of the hole in the center of the base. If it does not, remove the base and refill the slurry cup. Do not add cement through the hole in the base.

8. Screw the pivot bearing into the hole in the center of the base and tighten.
9. Wipe the entire slurry cup clean to ensure that no cement remains on the outside.

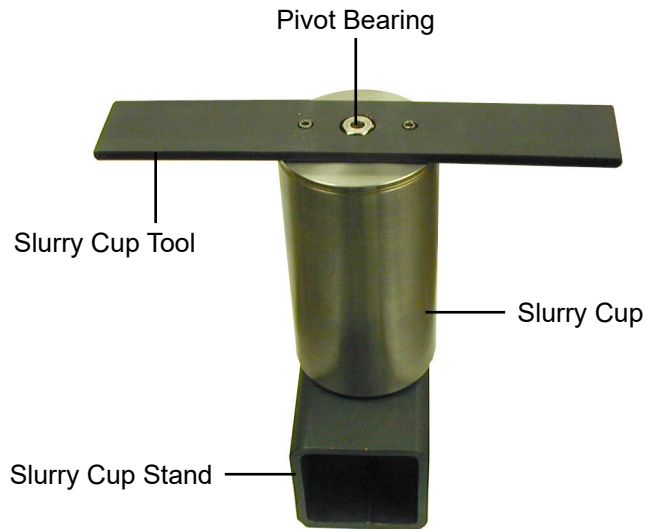

# Operation

## Starting a Test



Tip

1. Before turning on the Consistometer, make sure the MOTOR, HEAT, COOLING, PUMP, and FILL/DRAIN CELL switches are all off.
2. Turn the MAIN POWER switch on.
3. Turn the MOTOR switch on. This will start the motor.
4. Slowly lower the slurry cup into the test cell. When the slurry cup is lowered all the way, the drive table will engage with the drive pins on the bottom.
5. Lower the potentiometer into the test cell so that it sits on top of the slurry cup. Make sure the three contacts on the potentiometer engage with the contacts on the inside of the test cell.

The slurry cup and potentiometer both have two holes near the top for the lift tongs (provided). Use the lift tongs to easily lower the slurry cup and potentiometer into the test cell.

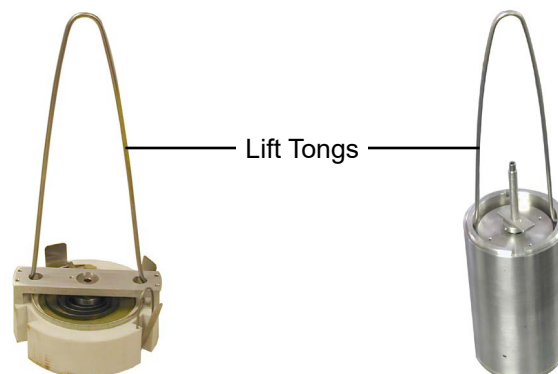

6. Turn the MOTOR switch to AUTO.
7. Carefully lower the cell cap into the test cell and tighten it.
8. Plug the thermocouple into the port near the test cell. Insert the thermocouple into the hole in the top of the cell cap and tighten the thread gland finger tight. Then loosen it  $\frac{1}{4}$  of a turn.
9. Close the pressure release valve by turning it clockwise.
10. Turn the FILL/DRAIN CELL switch to FILL. This will begin filling the cell with mineral oil. When the cell is full, oil will leak out of the thermocouple fitting on the cell cap. When this happens, tighten the fitting to seal the cell.

11. Turn the MOTOR, HEAT, COOLING, PUMP, and POT VOLTS switches to AUTO.

12. Load the test:

- a. If you will be using the software to run the test, select a Test Profile and click the Start Test button on the Main Screen (see page 21).
- b. If you will be using the onboard controls to run the test, first select a test to run (see page 29), then touch the Start Test button.

# Operation

## Completing the Test

When the slurry consistency reaches the maximum consistency set in the options (see page 18), the heater, motor, and pump will automatically turn off and the cooling system will turn on. The red light on the Status Indicator will turn on and an alarm will sound. To acknowledge the alarm, touch the alarm icon on the onboard display.

1. Turn the MOTOR and HEAT switches off.
2. Wait for the cell to cool. When the cell has cooled, turn the PUMP switch off and slowly open the Pressure Release valve.



### **Never release pressure while the temperature is above 190°F.**

If the pump switch is in the automatic position, the consistometer will maintain pressure above 5,000 PSI as long as the temperature above 190°F.

Always release the pressure **very slowly** to avoid pulling cement into the plumbing.



3. Turn the FILL/DRAIN CELL switch to DRAIN. This will allow air into the test cell and force the oil back into the reservoir.
4. When you hear air venting from the Consistometer, turn the FILL/DRAIN CELL switch off.
5. Remove the thermocouple from the cell cap.
6. Unscrew the cell cap and remove it from the test cell.
7. Remove the potentiometer and the slurry cup from the test cell.
8. Turn the COOLING switch off.
9. Return the cell cap to the test cell to prevent dust and other material from entering the cell. Turn the MAIN POWER switch off.



# Maintenance

## Cleaning

### Slurry Cup

After every test, immediately disassemble the slurry cup and clean it thoroughly with soap and water. Be sure to remove any residual cement before it hardens. Hardened cement on any of the parts can cause irreparable damage.

### Magnetic Drive

After every test, examine the inside of the test cell for any cement or other debris. Use a shop vacuum to remove any excess cement or debris that has settled into the bottom of the chamber. Additionally, remove the magnetic drive from the cell and clean off any excess cement that has accumulated on the shaft.



Tip

It is recommended that you periodically flush the test cell with mineral oil to clean out any contaminants that may have collected over time.

1. Make sure all switches are off and all valves are closed.
2. Open the test cell and remove the slurry cup and potentiometer if they are still in place.
3. Locate the cover and gland beneath the test cell and remove them.

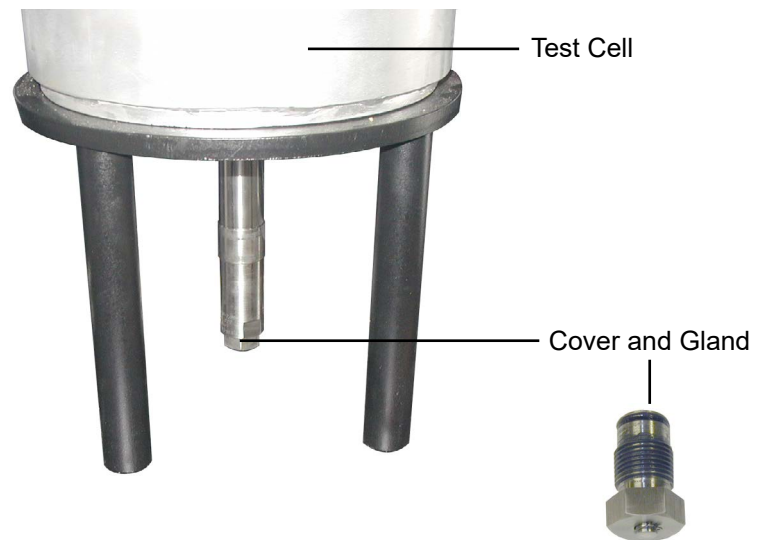

4. Pull the slurry cup table and rotor assembly up through the test cell opening.
5. Clean any abrasive particles from the rotor assembly and lay the assembly on a clean, flat, non-magnetic surface.
6. Place a pail or bucket underneath the test cell. Flush the test cell and magnetic drive with mineral oil. Use a soft-bristle brush to remove any debris.



Rotor Assembly



Rotor Assembly with  
Slurry Cup Table

7. Thread the slurry cup table onto the rotor shaft assembly.

Pour a small amount of mineral oil into the vessel. This will act as a cushion when inserting the rotor assembly.

8. Insert the rotor assembly into the drive housing. Press down on the slurry cup table until it falls into place.
9. Replace the cover and gland underneath the test cell before beginning another test.

### Filters

The instrument has an air filter and an air dryer. Both are located inside the cabinet on the left-hand side (see photo on page 44). Periodically check both of these for accumulated water. Unscrew the plug on the bottom and let the water drain.

The instrument has two oil filters. Both are inside the cabinet. The high-pressure filter is on the right-hand side and the low-pressure filter is on the bottom below the cell (see photo on page 44). The low-pressure filter should be replaced yearly. The high-pressure filter should be cleaned when the flow of oil back into the reservoir is obstructed (see page 45 for instructions).

# Maintenance

## Potentiometer

1. The potentiometer should be kept as clean as possible. Periodically submerge the unit in solvent to remove cement and other materials.

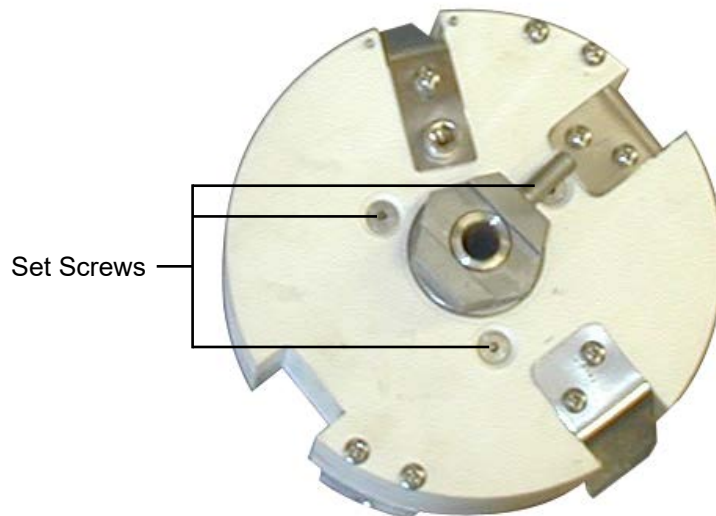
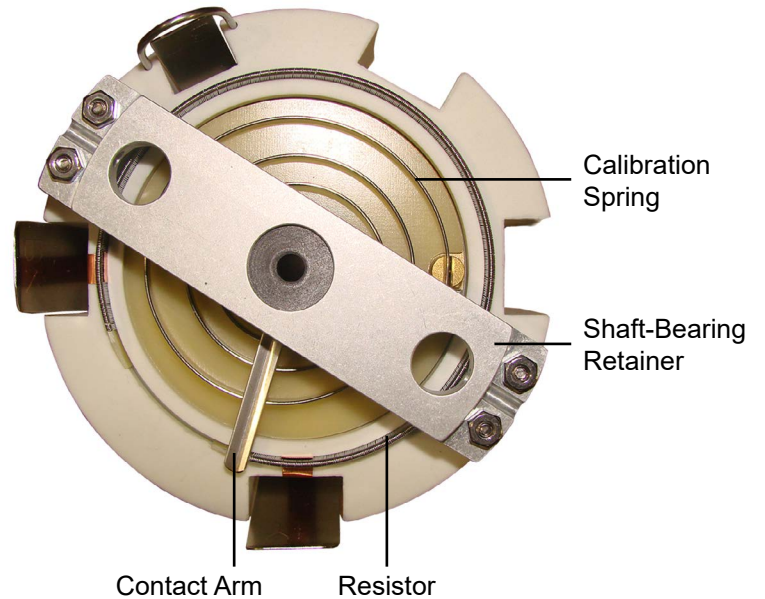

2. To install a new resistor:
  - a. Remove the four small screws holding the shaft-bearing retainer to the potentiometer assembly.
  - b. Remove the contact arm.
  - c. Carefully lift the damaged resistor away from the potentiometer. Clear the resistor groove of any foreign material.
  - d. Carefully place the new resistor into the groove and ensure that it is centered between the two terminating contacts.

- e. Push the resistor completely into the groove with either a mallet or a piece of wood. It is very important to ensure that the resistor is completely inserted into the groove and that the upper surface is level.
  - f. Install a new contact arm and if necessary, bend the arm either up or down to obtain consistent contact with the resistor.
  - g. Re-install the shaft-bearing retainer and calibrate the potentiometer before use.
3. To install a new calibration spring:
- a. Remove the contact arm and the shaft-bearing retainer.
  - b. Carefully lift the calibration spring from the potentiometer assembly.
  - c. Install the new spring. When properly installed, it should tighten when the center shaft is rotated counterclockwise.
  - d. Install a new contact arm and make adjustments as necessary to obtain consistent contact with the resistor.
  - e. Loosen the three adjustment screws on the underside of the potentiometer assembly and rotate the spring adjuster until the spring rests at a relaxed state.
  - f. Ensure that the contact arm aligns with the contact strip and tighten the three set screws.
  - g. Rotate the center shaft to ensure that the spring does not bind or rub the potentiometer housing.
  - h. Replace the shaft-bearing retainer and calibrate the potentiometer.

# Maintenance

## Rupture Disk

If you hear the pump running but no pressure is building in the test cell:

1. Make sure the "Pressure Release Valve" is completely closed.
2. Make sure the "FILL/DRAIN CELL" switch is set to FILL.
3. The Consistometer has a rupture disk to prevent damage due to over pressurization. If the pressure inside the cell exceeds 45,000–50,000 PSI, the disk will rupture and release the pressure. If this happens, the cell cannot be pressurized until the rupture disk has been replaced.

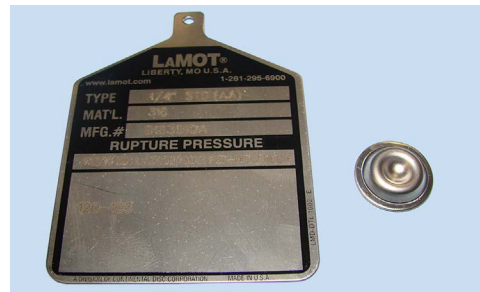

The rupture disk is located inside a square block just upstream from the filter on the inlet side of the pump. To replace the rupture disk, remove this block, discard the ruptured disk, and install a new disk. Then re-install the block into the plumbing line.

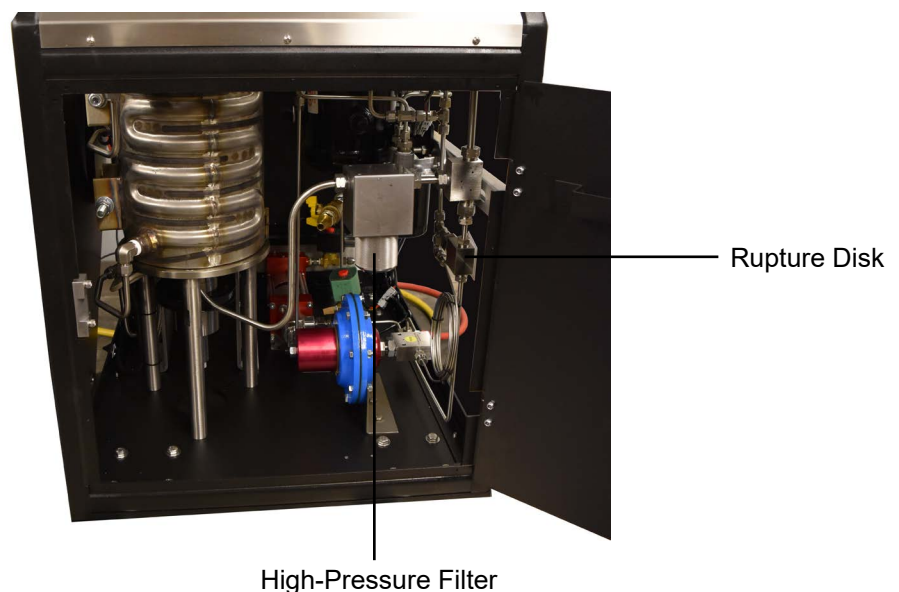

# Maintenance

## Oil Filter

When a test is complete, it should take several minutes to drain the test cell of oil. If it takes more than five minutes to completely drain the cell, the high-pressure filter may be clogged and need to be cleaned and replaced. It is recommended to clean this filter once a month during normal operation.

1. Locate the high-pressure filter inside the cabinet on the right-hand side.
2. Unscrew and remove the cylindrical filter housing.
3. Remove the filter element from inside the housing.
4. Clean the filter element with compressed air. This will blow out any dirt and debris.
5. Carefully place the filter element back inside the housing.
6. Screw the filter housing back into place.

If the high-pressure filter is dirty, it could mean that the oil in the reservoir is also dirty.

1. Make sure all pressure is released from the system and that the cell is open.
2. Make sure the "FILL/DRAIN CELL" valve is set to OFF.
3. Remove the reservoir cap.
4. On the bottom of the reservoir is a drain valve. Place a container underneath the drain and open the valve.
5. When the reservoir is empty, close the drain valve.
6. Pour approximately 4 liters of mineral oil into the reservoir.
7. Replace the reservoir cap. Make sure the seal is tight.

# Maintenance

## Pressure Relief Valve Regulator



**Note**

### Pressure Regulator

During a test, the computer will be continuously adjusting the pressure inside the cell. As the pressure increases due to thermal expansion, the computer will allow pressure to bleed. Likewise, if pressure begins to drop, the computer will add pressure to keep it within the target range.

There is a secondary **Regulator** (#120-50-037) which controls the air pressure to the pressure relief valve.

This regulator comes calibrated and requires no adjustment unless a part within this system has been replaced.

If the user must gain access to the regulator, simply remove the stainless steel drip tray on top of the cabinet. The regulator and gauge will be located underneath the tray. To set the regulator to the proper pressure, apply pressure to the system and begin opening the regulator between 60-70 psi. If the pressure relief valve does not open, continue adjusting the regulator to a higher pressure as needed to obtain optimal operation of the relief valve.

Air Regulator  
(#120-50-037)

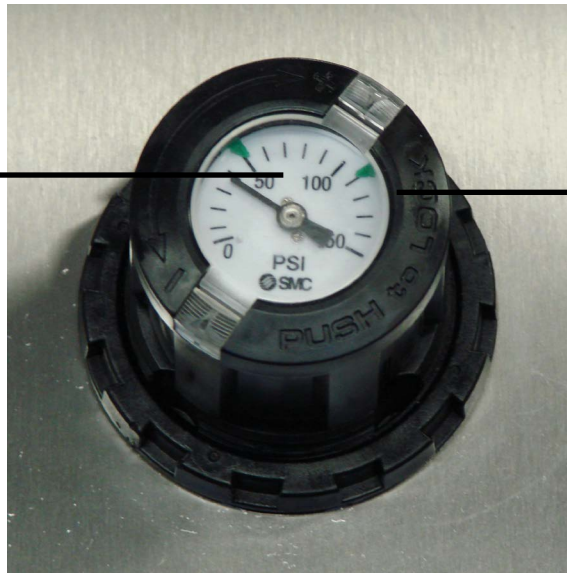

Gauge, 0 - 100 PSI  
(#113-00-022)

# Maintenance

## Troubleshooting

Symptom	Cause	Remedy
<b>Power</b>		
There is no power to the machine	The main power cord is not plugged in.	Make sure the main power cord(s) is firmly plugged into the wall and the machine.
	The main circuit breaker has tripped.	Check and reset the breaker.
<b>Heating / Cooling</b>		
The unit is not heating	The heater switch is not on.	Turn the heater switch on.
	The heater circuit breaker has tripped.	Check and reset the heater breaker.
	The Solid State Relay (SSR) is bad.	Replace the SSR (Contact OFITE).
	The unit is running on battery backup.	Heater will not turn on if the unit is running on battery backup.
The unit is overheating	The thermocouple is not plugged in completely.	Check the thermocouple and make sure the connections are secure.
	The thermocouple assembly is damaged.	Replace the thermocouple assembly.
	The Solid State Relay (SSR) is bad.	Replace the SSR (Contact OFITE).



Symptom	Cause	Remedy
<b>Heating / Cooling (Continued)</b>		
The unit is not able to maintain temperature or the temperature is cycling uncontrollably	The coolant water is on.	Turn off the cooling water.
	The thermocouple is not plugged in.	Plug in the thermocouple.
	Slurry cup paddle is out of alignment.	Make sure the paddle sits on the pivot bearing properly.
	Pressure leak.	Check for pressure fluctuations or leaks.
The unit is not cooling	The unit is not cooling.	Make sure the cooling water is switched on at the source.  Make sure the cooling switch is set to Auto or On.  Make sure the Heat switch is Off.  Make sure the cooling lines are free from obstructions.  The cooling solenoid is not functioning (Contact OFITE).
	Cooling solid state relay is bad.	Replace the cooling solid state relay (Contact OFITE).
<b>Thermocouple</b>		
Thermocouple will not fit into the slurry cup	The thermocouple is bent.	Straighten the thermocouple. Replace the thermocouple.
	The shaft on the slurry cup is bent and/or damaged.	Replace the slurry cup shaft.
	The diaphragm is damaged.	Replace the diaphragm.
<b>Pressure</b>		
The unit will not hold pressure	The cell cap o-ring is leaking.	Replace the cell cap o-ring.
	There is a leak at one of the fittings.	Trace the tubing and tighten the leaking connection.
	The pressure release valve (PRV) is damaged.	Replace the PRV.
	Not enough oil in reservoir	Check the level in the reservoir and add if needed.

Symptom	Cause	Remedy
<b>Pressure (Continued)</b>		
	The mag drive shaft o-ring is leaking.	Replace the mag drive shaft o-ring (Contact OFITE).
	The heater element seal is leaking.	Replace the heater element seal (Contact OFITE).
	Spring in check valve is stuck.	Disassemble check valve and stretch out the spring.
The unit will not build pressure	The cell cap o-ring is leaking.	Replace the cell cap o-ring.
	There is a leak at one of the fittings.	Trace the tubing and tighten the leaking connection.
	The pump is broken (not cycling, constantly cycling).	Replace the pump.
	The Rupture Disk is blown.	Replace the Rupture Disk see page 44.
	Pressure Release Valve is open.	Completely close the Pressure Release Valve.
	The Fill/Drain Cell switch is set to Drain.	Switch it to Fill.
	Not enough oil in the reservoir.	Check the level in the reservoir and add if needed.
	No air supplied to the unit. Air filter is full of water.	Make sure air is properly supplied to the unit.
	The air filter is full of water.	Empty the water from the air filter.
	Air solenoid is damaged.	Replace air solenoid (Contact OFITE).
The unit applies too much pressure	The high-pressure relief coil is clogged.	Remove the coil and clean it with Nitrogen (1,500 - 2,000 psi)
	Air-operated valve is leaking or damaged.	Replace the valve (Contact OFITE).
	Pressure relief valve regulator is not properly set	Adjust regulator to appropriate value (see page 46).

<b>Potentiometer</b>		
The consistency/voltage readings fluctuate.	The resistor is not level.	Carefully remove and reinstall the resistor so that the upper edge is flat and level.
	The resistor has excess powder coating from the factory.	Use an emery cloth to clean the upper and lower edge of the resistor.
	There is a short in the contact pin.	Replace the contact pin (Contact OFITE).
	The potentiometer shaft is loose.	Tighten the potentiometer shaft.
The consistency/voltage readings are zero	The drive bar on the slurry cup is loose.	Tighten the drive bar.
	The contact arm is not touching the resistor.	Check the contact arm to ensure that it contacts the entire length of the resistor. Bend the arm if necessary.
The potentiometer will not hold calibration.	The resistor wire is broken.	Replace the resistor wire.
	The three screws on the bottom of the potentiometer body are loose.	Tighten the three screws.
	The resistor is bad.	Replace the resistor.

# Calibration

## Potentiometer

To ensure accurate readings, the potentiometer should be calibrated at least once a month or whenever any component of the potentiometer is changed. Also, calibrate the potentiometer when the software or firmware are updated.

1. Place the potentiometer on the calibration stand. Place the stand on the edge of the Consistometer and plug it into the port on the underside of the control panel.

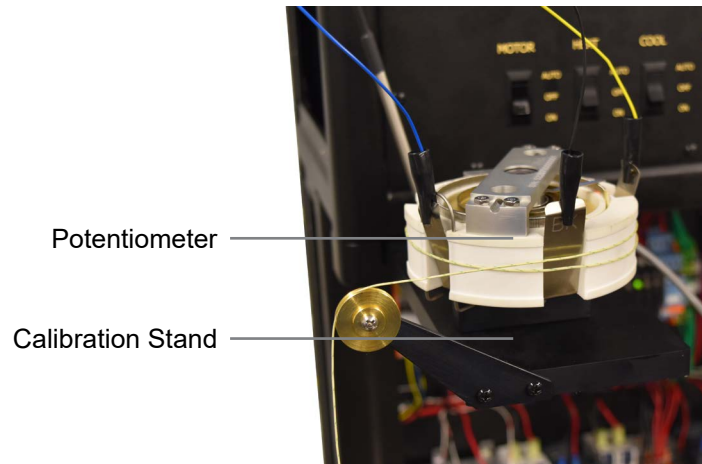

2. Connect the wire clamps to the contacts. From the groove going clockwise around the unit, connect yellow, then black, then blue. The contacts are labelled for the correct color. BL = Blue. BK = Black. YL = Yellow.
3. Slide the weight into the groove and wrap the cord clockwise around the unit one full turn.
4. Let the cord hang over the wheel and off the table.
5. Attach the hook to the cord.

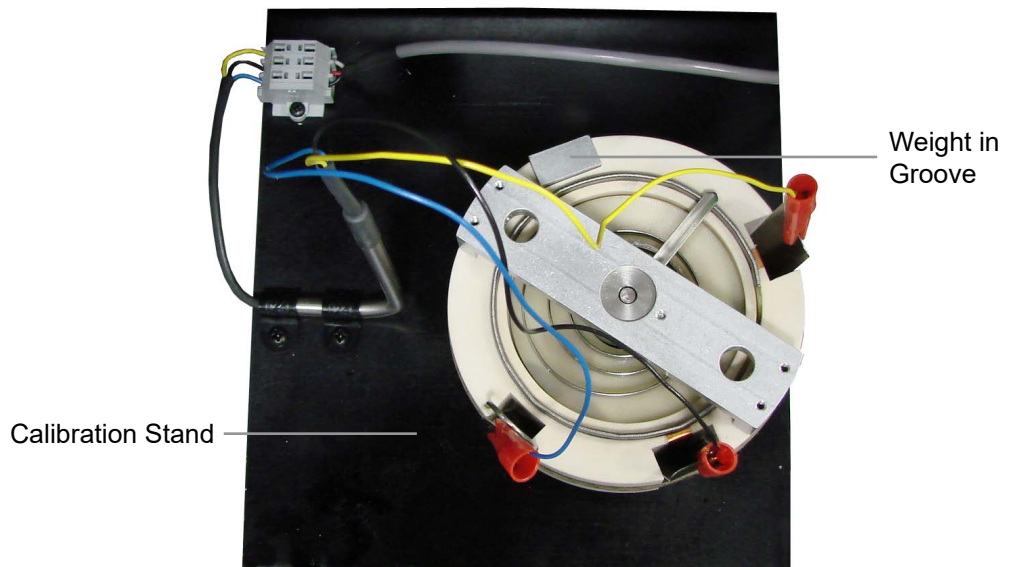

6. Turn the "POT VOLTS" switch to On.
7. Start the calibration procedure:
  - a. For onboard control, touch Calibrate and then Consistency.
  - b. For software control, select Consistency from the Calibrate menu.
8. The screen will prompt you to add weights to the potentiometer. After you add the weight, steady the cord to minimize the amount of swinging. Firmly tap the surface of the calibration stand to settle the weights and stabilize the potentiometer.



**Note**

When adding weights, remember that the hook weighs 50 grams. Therefore, to test the potentiometer at 200g, you only need to add 150g to the hook.

9. Lift the weight about two inches directly upward and release it. Allow it to fall straight down. When the reading stabilizes, touch the ">" button and click "Next".
10. Continue adding weights when prompted.
11. After all weights have been recorded, the results will display on the screen.



**Note**

The API specifies that each calibration point must be within 5 Bc of the standard. If any calibration point is outside this range, the entire calibration will fail.

# Calibration

## Value Chart

Torque Equivalent g•cm	Mass of Reference Weights g ± 0.1 g	Slurry Consistency $B_c$ ± 5
260	50	9
520	100	22
780	150	35
1,040	200	48
1,300	250	61
1,560	300	74
1,820	350	87
2,080	400	100

<sup>a</sup>For a potentiometer mechanism with a different radius, an appropriate table with equivalent tolerances shall be used

# Calibration

## Pressure

The pressure should be calibrated at least yearly or whenever the pressure transducer has been replaced.

1. Connect a calibrated pressure gauge to the thermocouple port in the cell cap.
2. Start the calibration procedure:
  - a. For onboard control, touch Calibrate and then Pressure.
  - b. For software control, select Pressure Transducer from the Calibrate menu.
3. Follow the instructions on the screen.



# **Calibration**

## *Temperature*

The thermocouple will require calibration quarterly or if it is replaced.

1. Place the thermocouple in a dry block calibrator.
2. Start the calibration procedure:
  - a. For onboard control, touch Calibrate and then Temperature.
  - b. For software control, select Temperature from the Calibrate menu
3. Follow the instructions on the screen.



# Appendix

## Metal Seal Ring Installation



### Note

Two o-rings are available for the cell cap. The rubber o-ring is easier to use, but is not suitable for tests involving high temperature or pressure. The metal o-ring is more durable, but requires extra attention when tightening the cell cap. Once you have chosen an o-ring, place it into the test cell in the o-ring groove.

The installation of the metal seal ring is a straight forward procedure. If done correctly, the seal ring life can be extended indefinitely. The key will be to tighten the chamber lid to crush the o-ring just enough to prevent the cell from leaking.

If the o-ring is over crushed, the upper surface of the o-ring will be level with the inside lip. This will prevent the mandrel from making a good seal and keep the cell from leaking.

1. Mark the cell body and cap to indicate full closure. If the cell assembly has these markings, skip to Step 2.
  - a. Place the mandrel in the cell with no o-ring installed.
  - b. Screw on the cap until the cap stops on top of the mandrel.
  - c. Using a Sharpie, make a light mark indicating where the cap and body line up.
  - d. Remove the cap and mandrel.
2. Install the o-ring into the o-ring groove inside the cell. Ensure the o-ring is sitting flush with the o-ring groove.
3. Close the cell and screw the cell cap down hand tight. The arrows will not line up.



Installed  
Metal O-ring

4. Use a mallet to help tighten the lid down. For the first attempt, tighten the lid down half the distance from the previous stopping point.



5. Remove the lid and check the o-ring. If the o-ring can spin freely in the groove, the o-ring has not been crushed enough. Replace the lid and continue tightening with the mallet. Remove the lid and check the o-ring. Continue this process until the o-ring is set.
6. Once the o-ring is set, make a mark with a permanent marker that lines up with the mark on the upper lid.
7. Fill the cell with oil and perform a pressure test. Manually increase the pressure in steps of 5,000 PSI up to 25,000 PSI. Hold the pressure at each step for 10 minutes to ensure that the cell is not leaking from around the cell lid.
8. If the cell leaks from around the o-ring, drain the cell and use the mallet to deliver a couple of blows to tighten the lid a bit more.
9. Close up the cell and fill it with oil. Repeat the pressure test procedure until the cell is able to hold pressure.



**Note**

Please note, the arrows may or may not line up when the cell is properly sealed. The cell should be marked at the final position of the arrow on the lid to indicate the final position of the cell. If the cell is ever tightened past this mark, the mark will need to be removed and the cell will need to be marked at the new position.



**Note**

One final check to make on the cell o-ring will be to physically check and make sure the upper surface of the o-ring sticks up above the o-ring ledge around the entire circumference of the cell.

If the o-ring is damaged and unable to seal, the o-ring will need to be replaced.

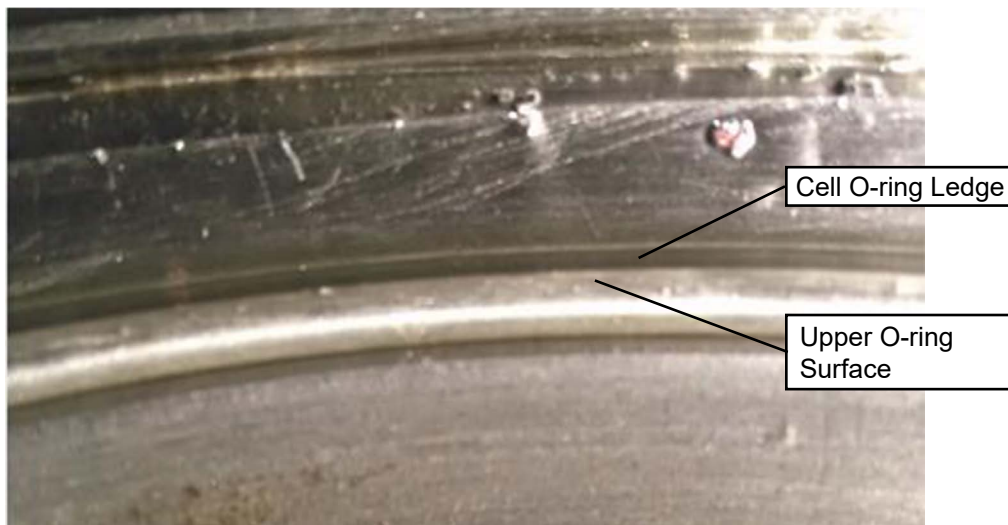

# Appendix

## Cell Diagram

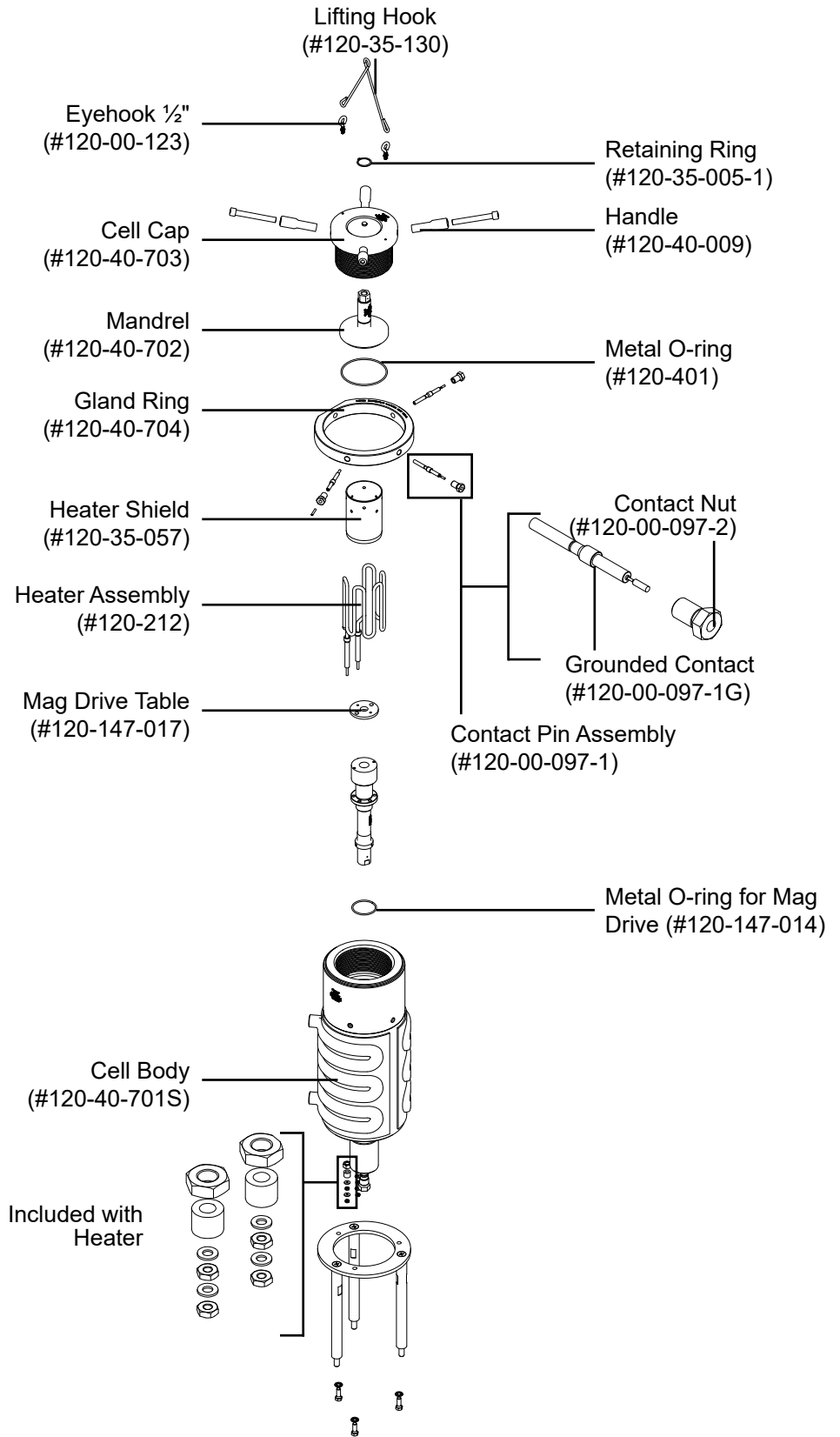

# Appendix

Slurry Cup Diagram

## #120-521 Slurry Cup Assembly With Expansion Chamber

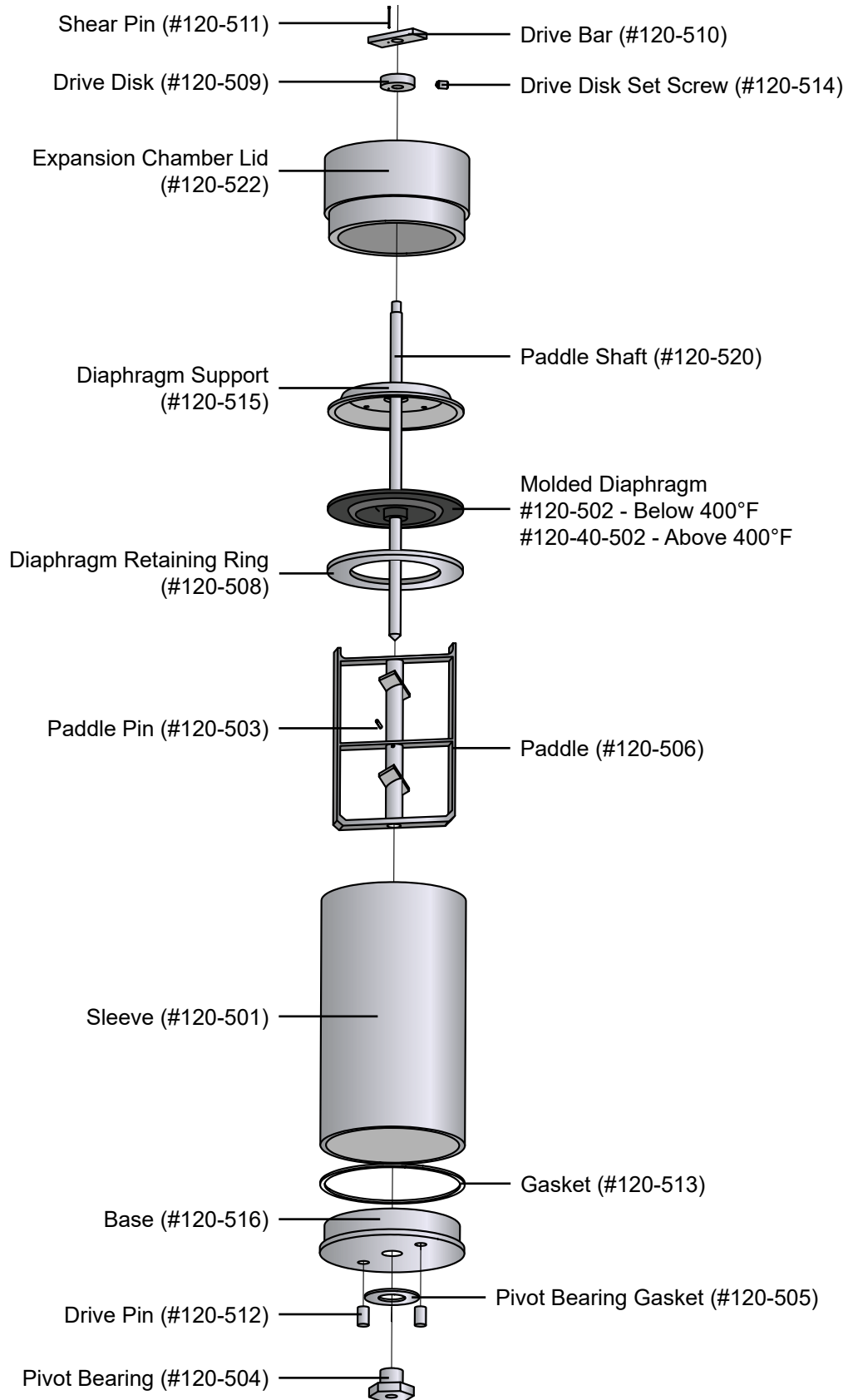

## #120-519 Slurry Cup Assembly Without Expansion Chamber

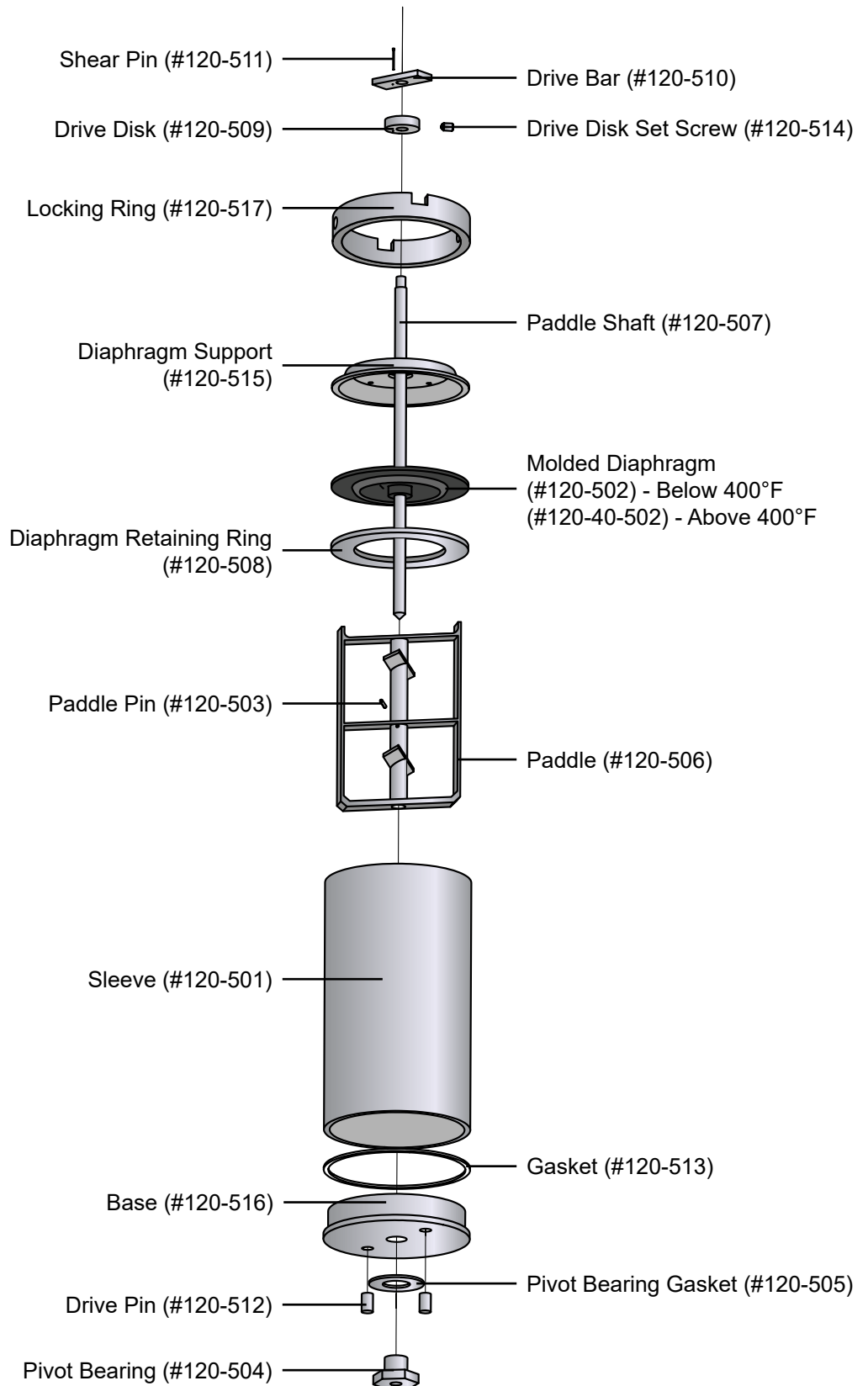

# Appendix

## Potentiometer Diagram

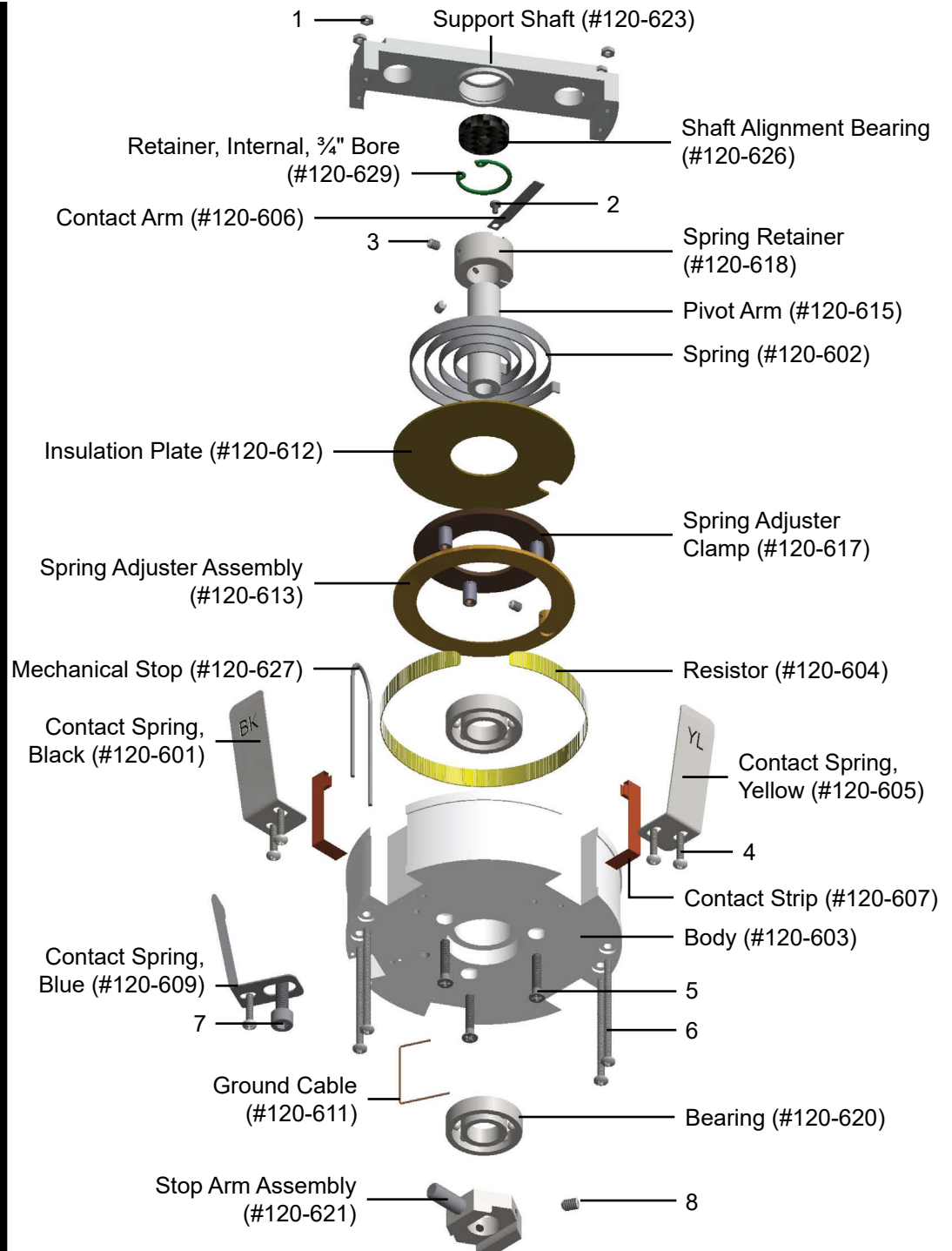

1.	WHS	Nut, 4-40, 3/16"W × 1/8"H, Qty. 4
2.	#120-619	Screw, Phillips, Pan Head, 2-56 × .125L
3.	#120-616	Set Screw, Hex, 6-32 × .1875L, Qty. 3
4.	#120-610	Screw, Phillips, Pan Head, 4-40 × .375L, Qty. 5
5.	#120-614	Screw, PHillips, Countersink, 6-32 × .75L, Qty. 3
6.	WHS	Screw, Phillips, Pan Head, 4-40 × 1.5L, Qty. 4
7.	#120-608	Screw, Hex Socket, 10-32 × .5L
8.	#120-622	Set Screw, Hex, 8-32 × .25L, Qty. 2

# Appendix

## Potentiometer Adjustment

The calibration spring has a zero point. If the contact arm is behind the zero point, the potentiometer will register a negative reading. If the contact arm drifts behind the zero point, it will be necessary to adjust the position of the spring.

1. Remove the potentiometer from the consistometer.
2. Loosen the three set screws on the bottom of the potentiometer.
3. Locate the spring holder on the top of the potentiometer. It may be positioned beneath the shaft bearing retainer. Push the spring holder to rotate the spring within the body of the potentiometer.
4. When the contact arm is again in front of the zero point, tighten the set screws to secure it in place.
5. The contact arm may drift while tightening the set screws. Recheck the position of the contact arm before using the potentiometer.

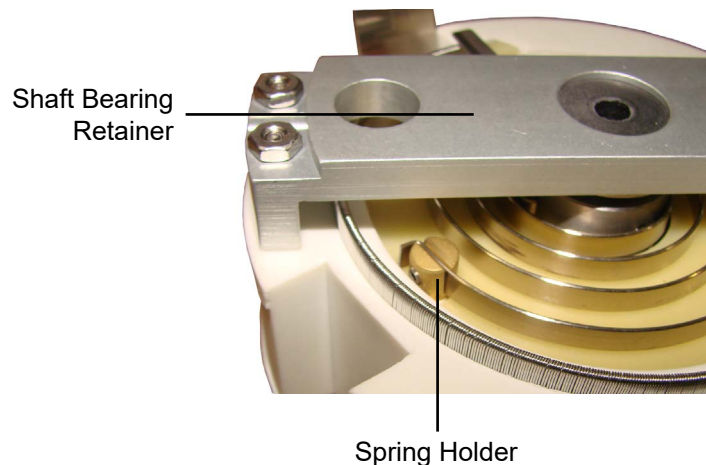
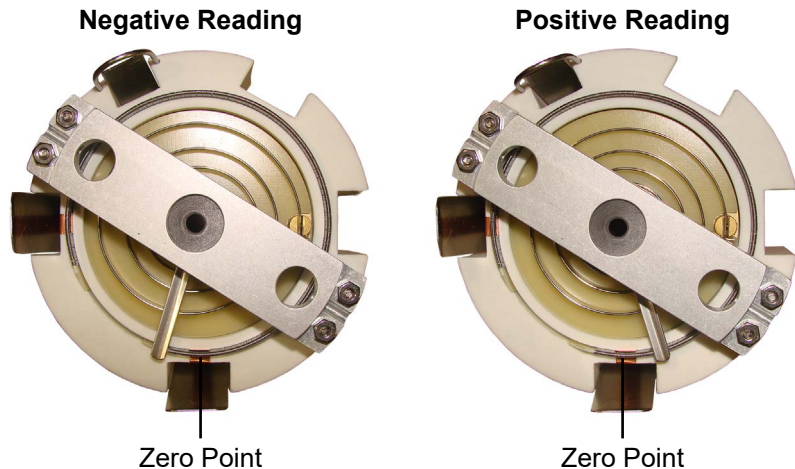



# Appendix

## Fuses and Breakers

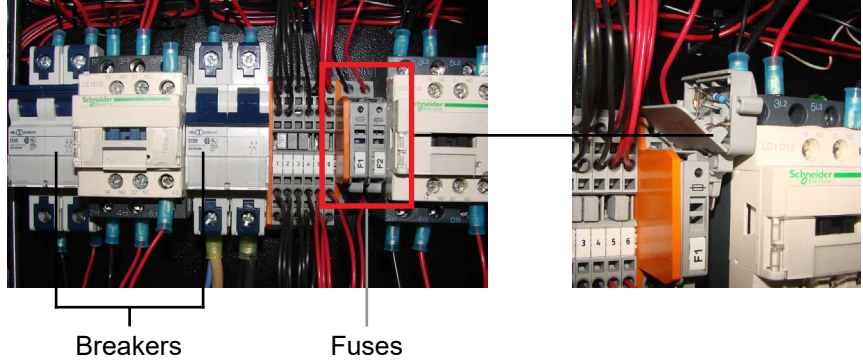

Tip

If there is no power to the machine, it could be that the fuse for the main power supply is blown or that the main circuit breaker has tripped.

1. Check the breaker switches and make sure they are in the on position.
2. Open the fuses holders to check the condition of the fuses. If they have blown, replace them (both fuses are 5 amp).

# Appendix

## Multiple Instruments

It is possible to control multiple HTHP Consistometers from a single computer. To setup the software for multiple HTHP Consistometers, repeat the following procedure for each instrument.

1. Plug each instrument into a separate serial port on the computer.
2. On the computer, navigate to the “C:\Program Files (x86)” folder.
3. Locate the “HTHP Consistometer” folder and select it.
4. Hold down the CTRL key and then hit "C". Then hold down the CTRL key and hit V. This will create a duplicate of the folder called “HTHP Consistometer - Copy”.
5. Choose a name to identify the new instrument.
6. Rename the new folder with the name of the instrument.
7. Locate the program file (.exe) inside the folder and rename it with the name of the instrument.



Tip

For convenience, create a shortcut to this file on the desktop.



Note

8. Open the software using the new program file.
9. Change the “Archive Path” to a new folder.

Each instrument must have its own Archive Path.

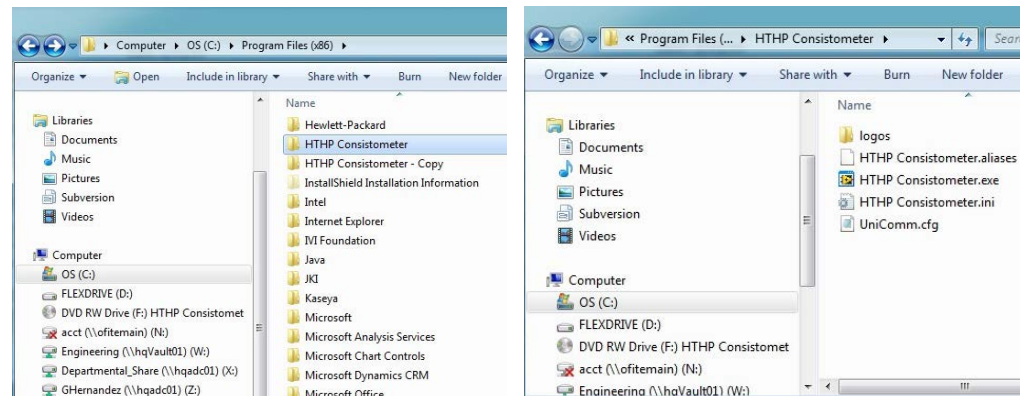

# Warranty and Return Policy

## Warranty:

OFI Testing Equipment, Inc. (OFITE) warrants that the products shall be free from liens and defects in title, and shall conform in all respects to the terms of the sales order and the specifications applicable to the products. All products shall be furnished subject to OFITE's standard manufacturing variations and practices. Unless the warranty period is otherwise extended in writing, the following warranty shall apply: if, at any time prior to twelve (12) months from the date of invoice, the products, or any part thereof, do not conform to these warranties or to the specifications applicable thereto, and OFITE is so notified in writing upon discovery, OFITE shall promptly repair or replace the defective products. Notwithstanding the foregoing, OFITE's warranty obligations shall not extend to any use by the buyer of the products in conditions more severe than OFITE's recommendations, nor to any defects which were visually observable by the buyer but which are not promptly brought to OFITE's attention.

In the event that the buyer has purchased installation and commissioning services on applicable products, the above warranty shall extend for an additional period of twelve (12) months from the date of the original warranty expiration for such products.

In the event that OFITE is requested to provide customized research and development for the buyer, OFITE shall use its best efforts but makes no guarantees to the buyer that any products will be provided.

OFITE makes no other warranties or guarantees to the buyer, either express or implied, and the warranties provided in this clause shall be exclusive of any other warranties including ANY IMPLIED OR STATUTORY WARRANTIES OF FITNESS FOR PURPOSE, MERCHANTABILITY, AND OTHER STATUTORY REMEDIES WHICH ARE WAIVED.

This limited warranty does not cover any losses or damages that occur as a result of:

- Improper installation or maintenance of the products
- Misuse
- Neglect
- Adjustment by non-authorized sources
- Improper environment
- Excessive or inadequate heating or air conditioning or electrical power failures, surges, or other irregularities
- Equipment, products, or material not manufactured by OFITE
- Firmware or hardware that have been modified or altered by a third party
- Consumable parts (bearings, accessories, etc.)

## Returns and Repairs:

Items being returned must be carefully packaged to prevent damage in shipment and insured against possible damage or loss. OFITE will not be responsible for equipment damaged due to insufficient packaging.

Any non-defective items returned to OFITE within ninety (90) days of invoice are subject to a 15% restocking fee. Items returned must be received by OFITE in original condition for it to be accepted. Reagents and special order items will not be accepted for return or refund.

OFITE employs experienced personnel to service and repair equipment manufactured by us, as well as other companies. To help expedite the repair process, please include a repair form with all equipment sent to OFITE for repair. Be sure to include your name, company name, phone number, email address, detailed description of work to be done, purchase order number, and a shipping address for returning the equipment. All repairs performed as "repair as needed" are subject to the ninety (90) day limited warranty. All "Certified Repairs" are subject to the twelve (12) month limited warranty.

Returns and potential warranty repairs require a Return Material Authorization (RMA) number. An RMA form is available from your sales or service representative.

Please ship all equipment (with the RMA number for returns or warranty repairs) to the following address:

OFI Testing Equipment, Inc.  
Attn: Repair Department  
11302 Steeplecrest Dr.  
Houston, TX 77065  
USA

OFITE also offers competitive service contracts for repairing and/or maintaining your lab equipment, including equipment from other manufacturers. For more information about our technical support and repair services, please contact [techservice@ofite.com](mailto:techservice@ofite.com).